

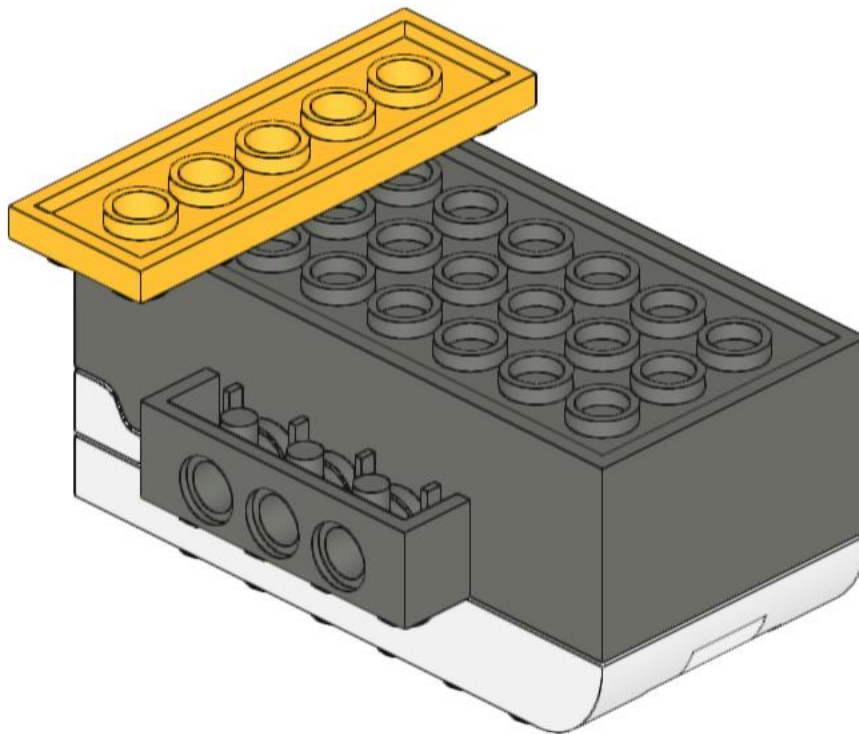

Car

1

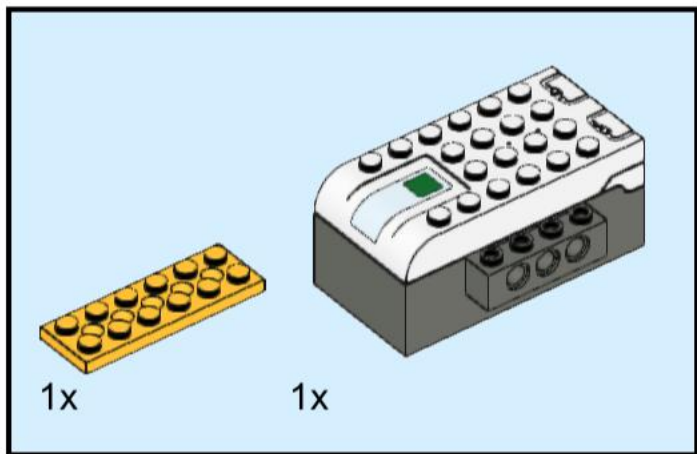

2

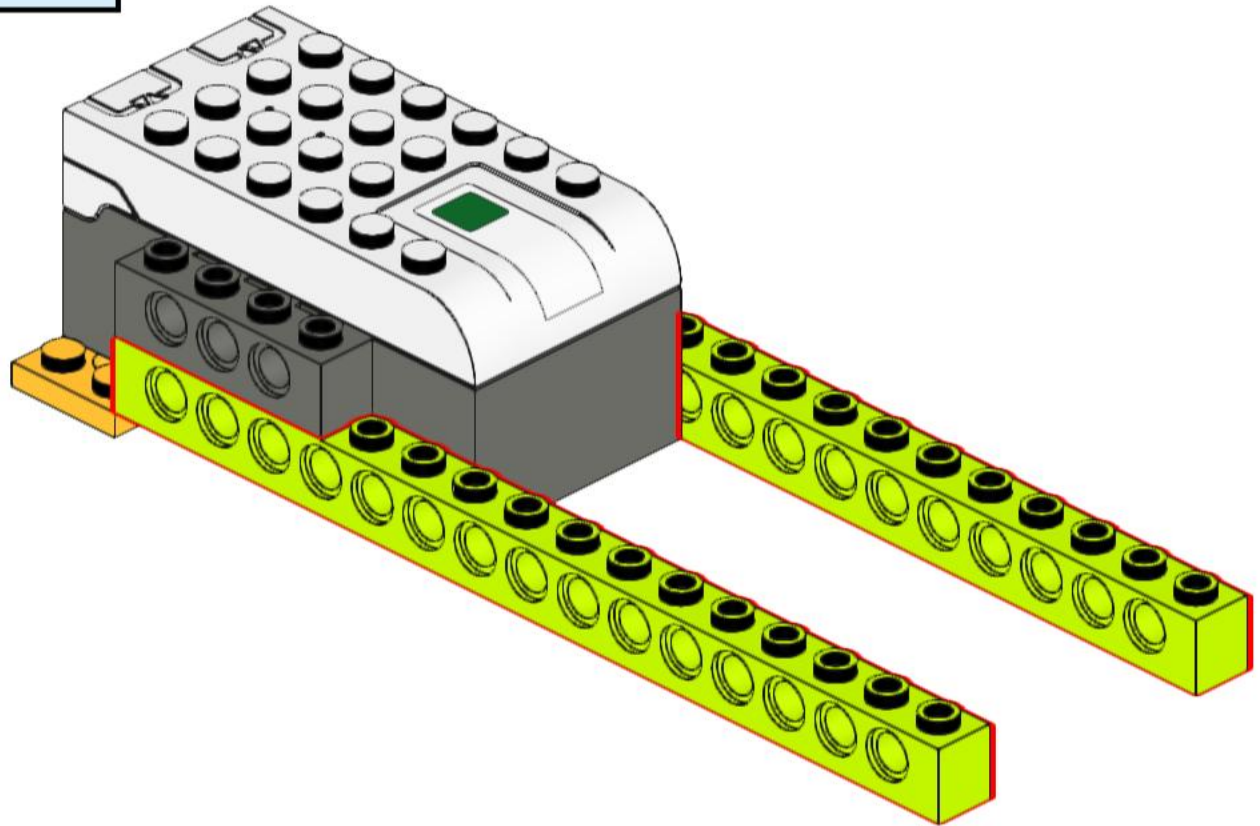
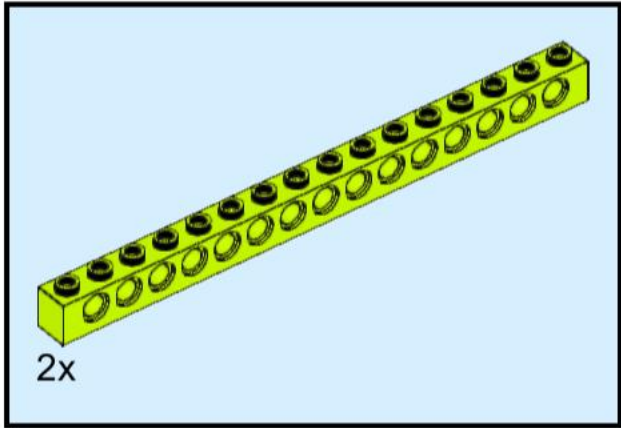

3

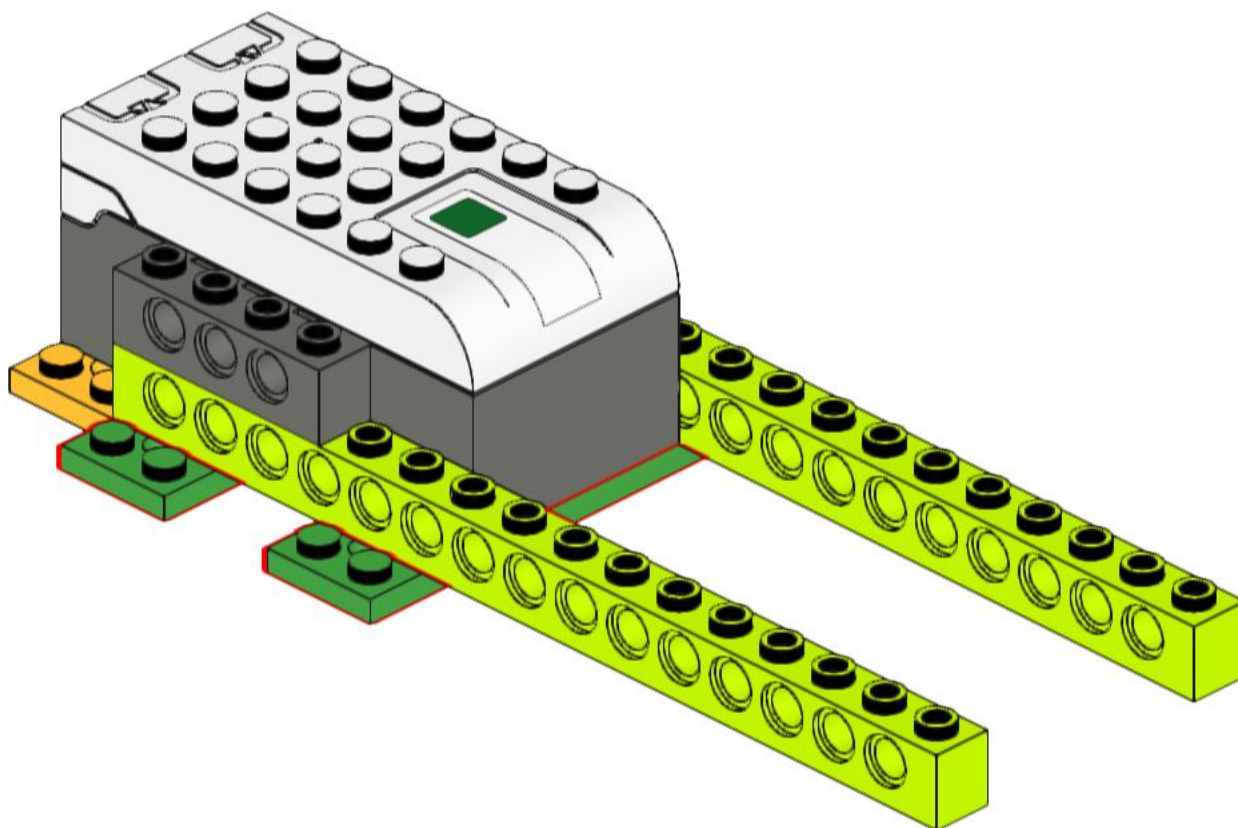
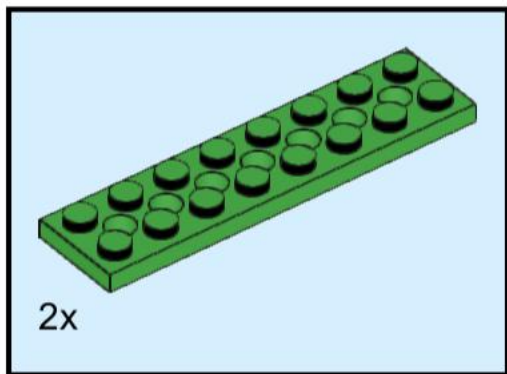

4

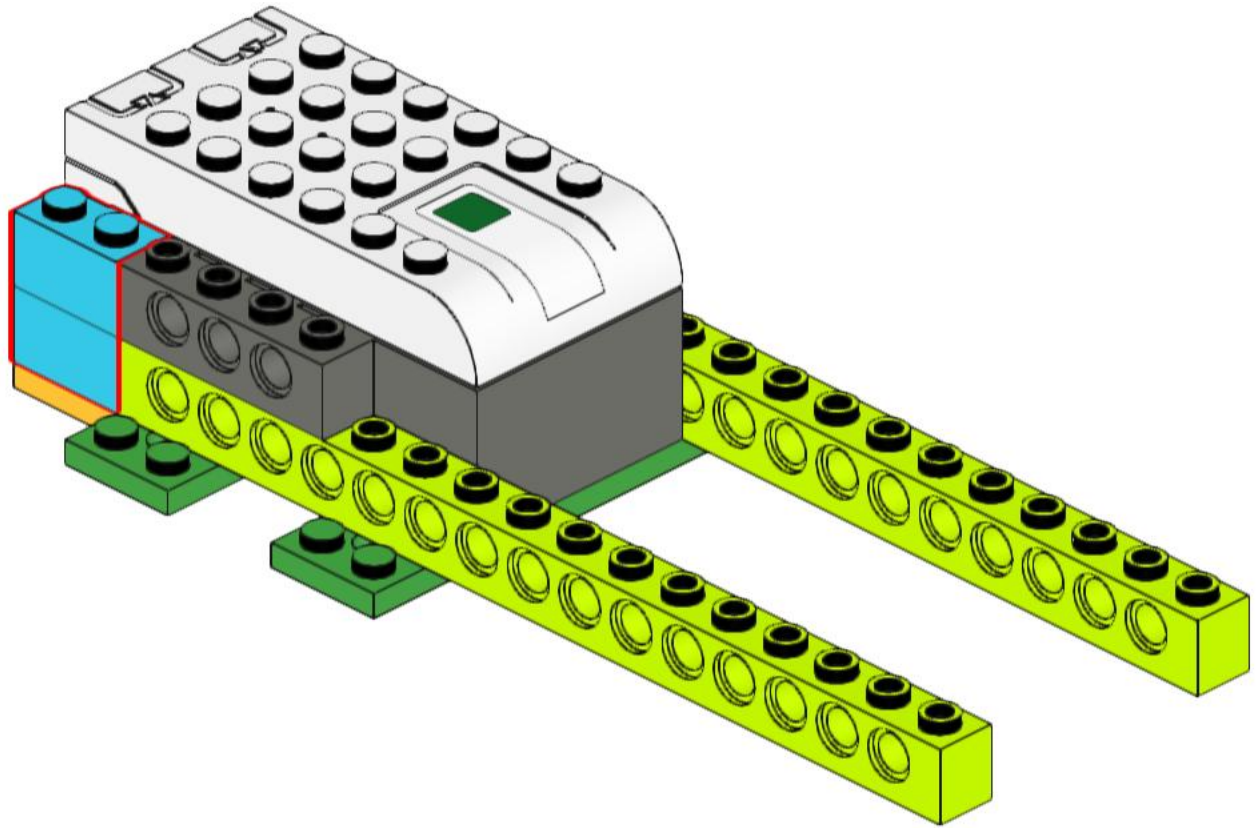
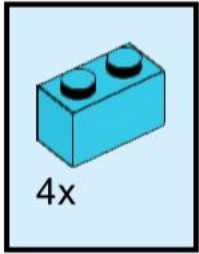

5

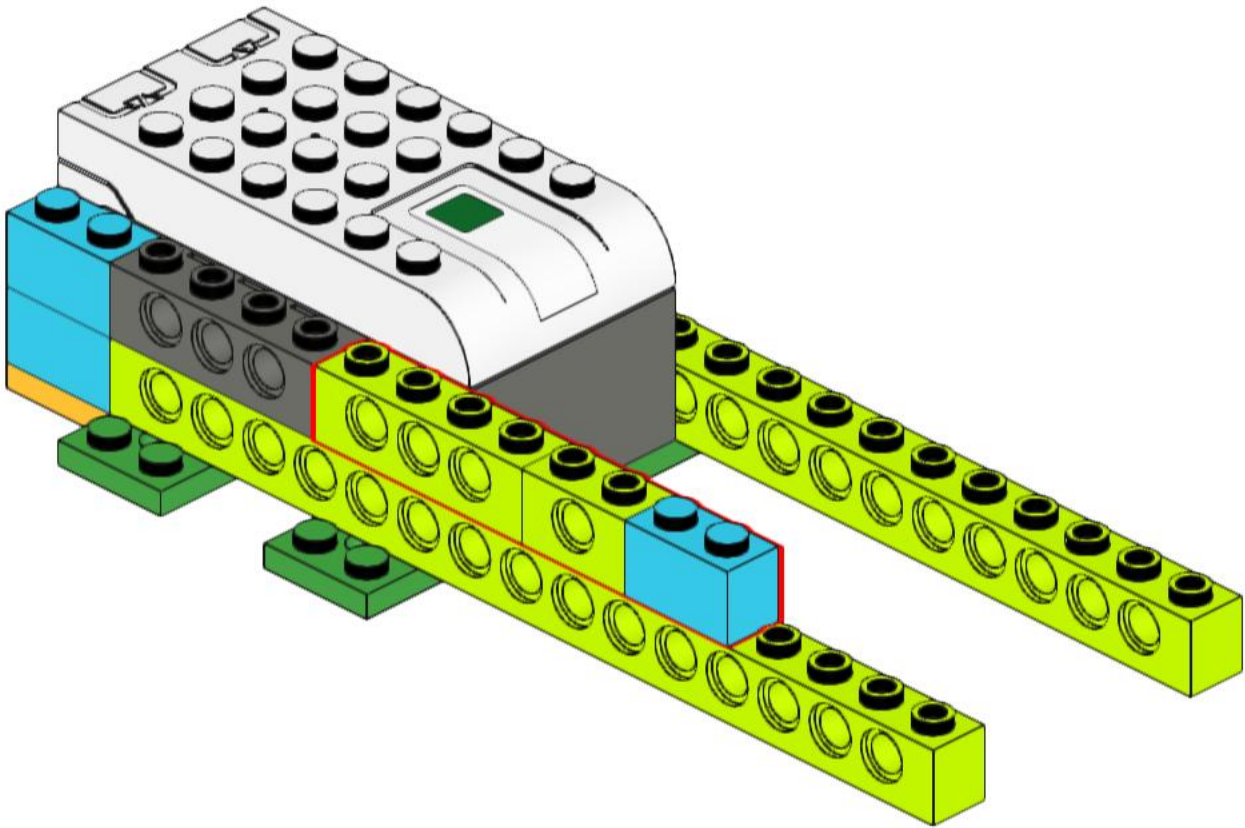
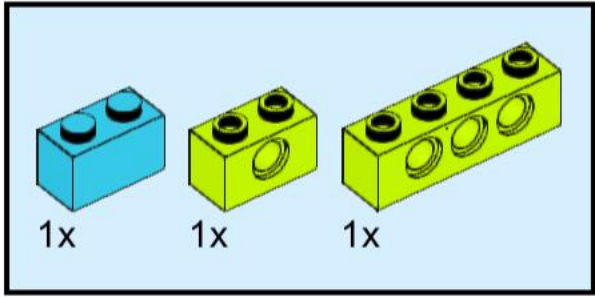

6

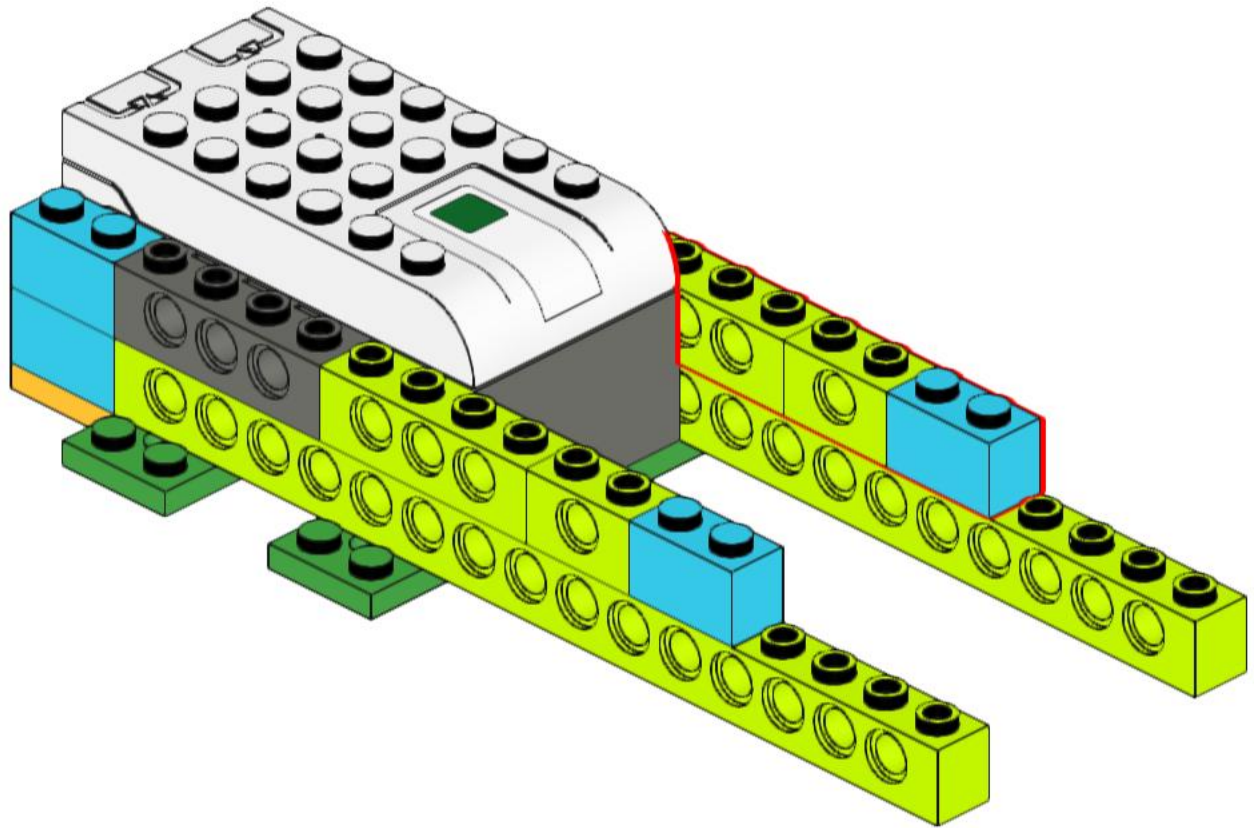
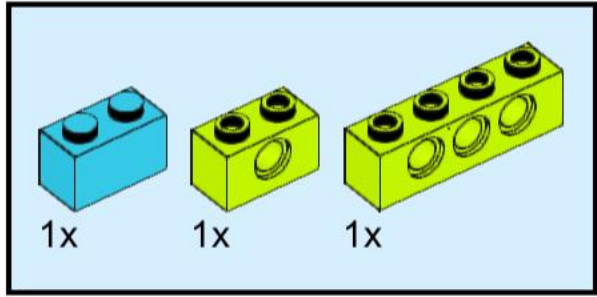

7

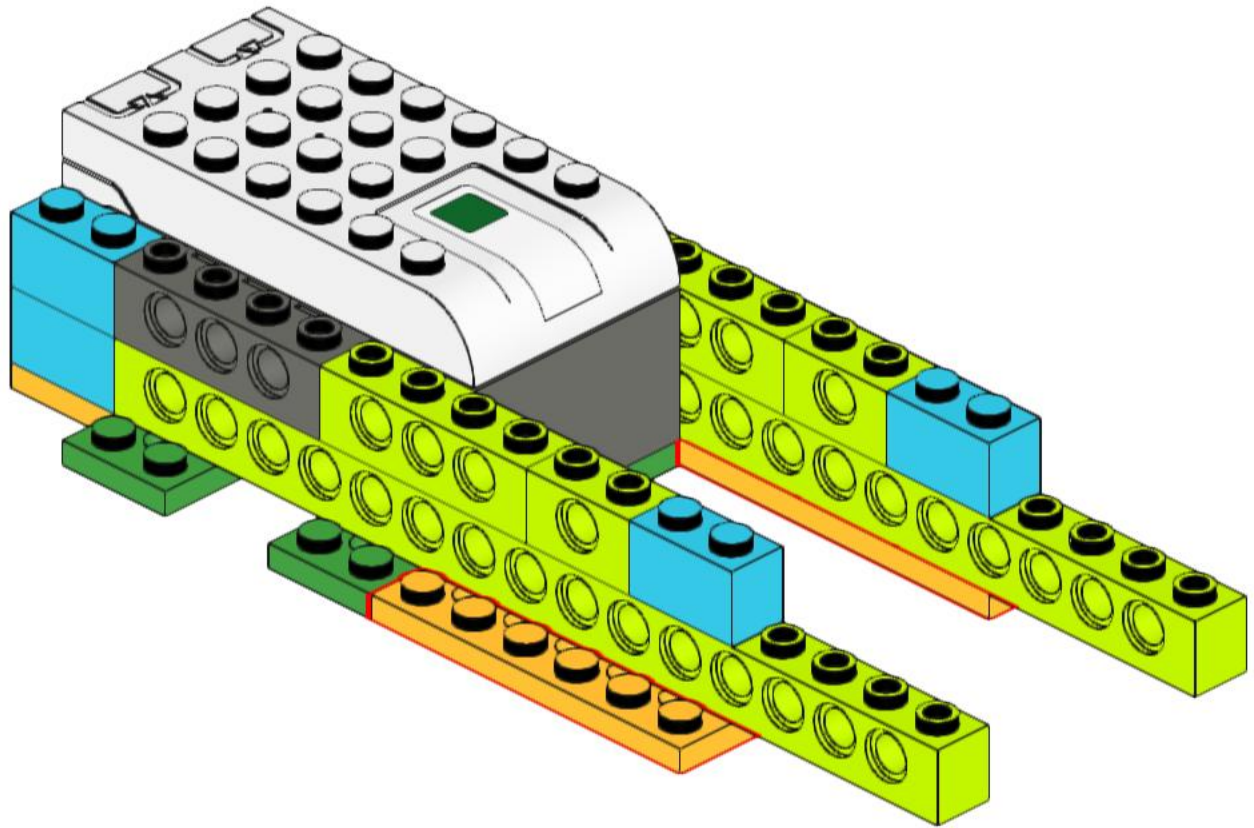
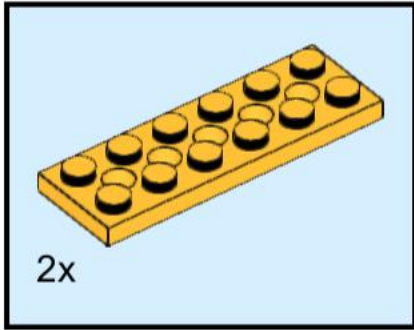

8

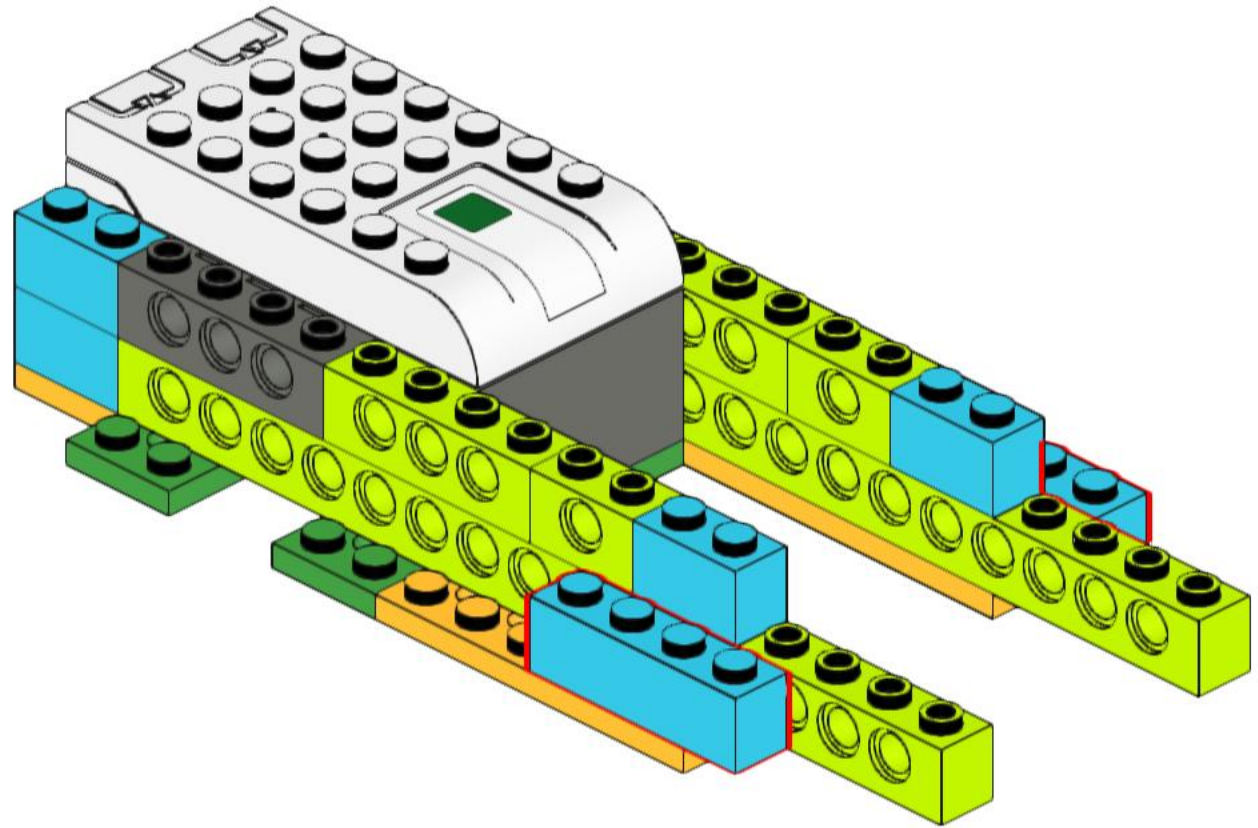
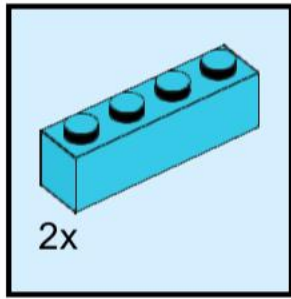

9

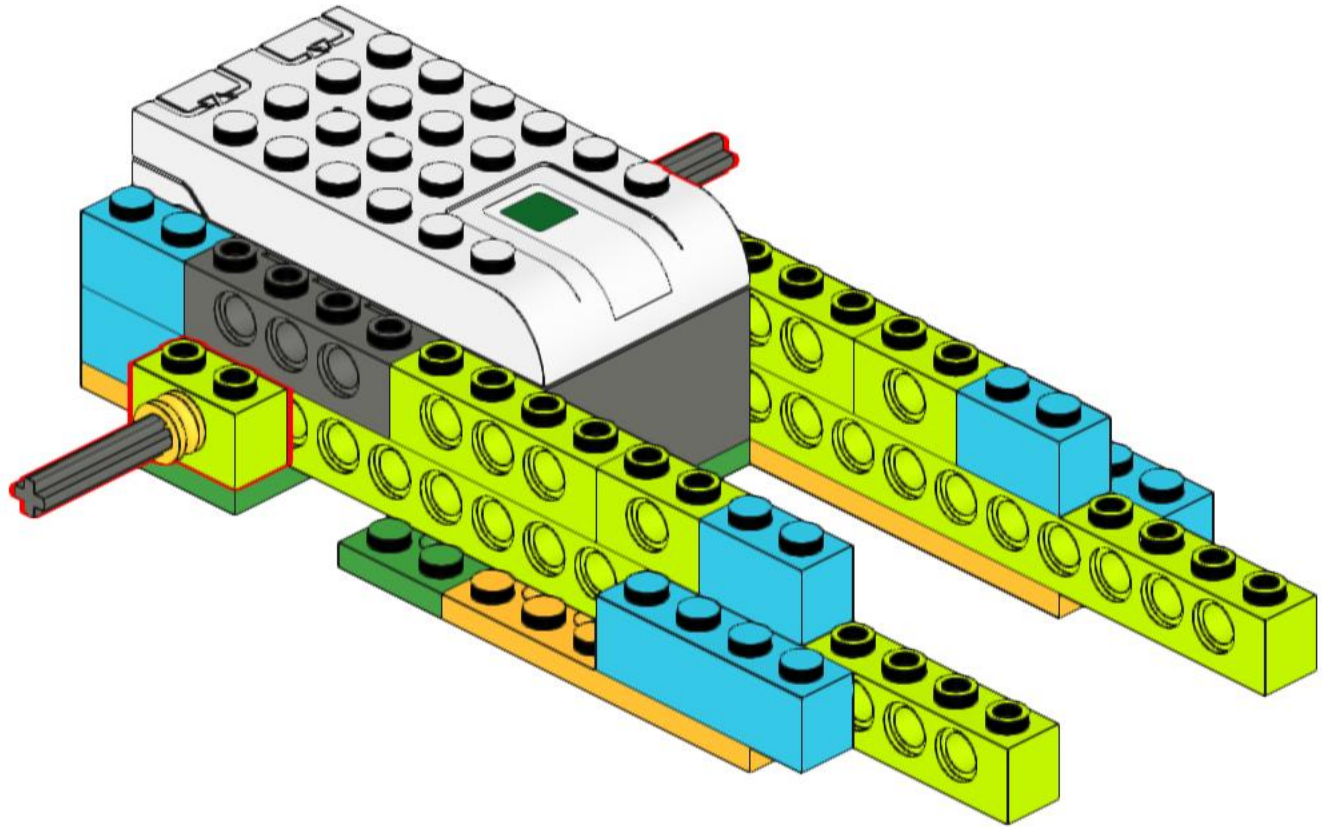
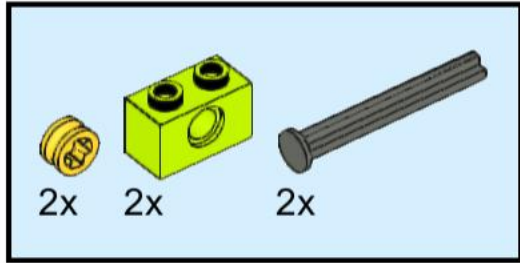

10

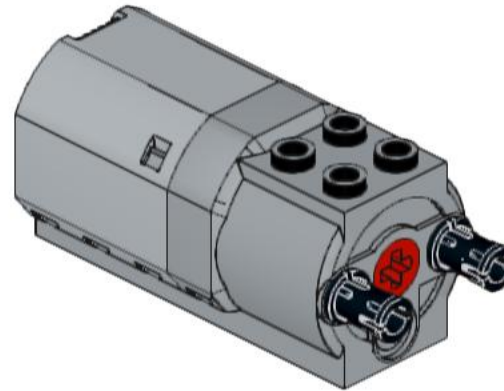
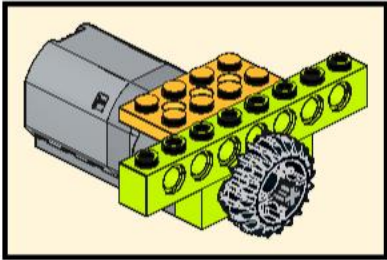
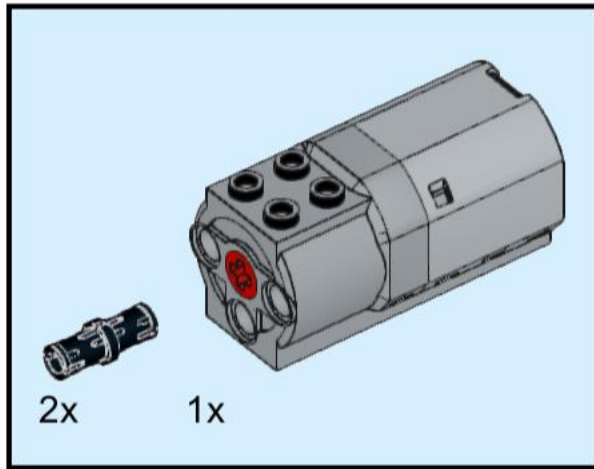

11

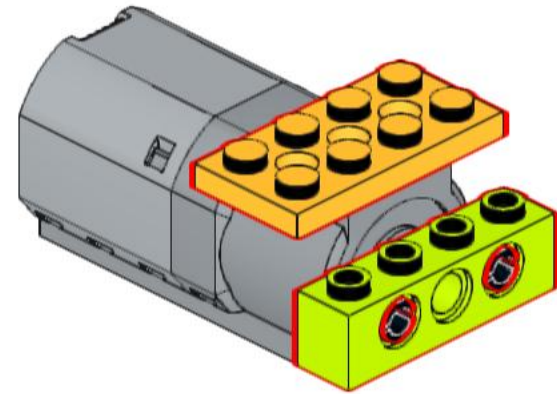
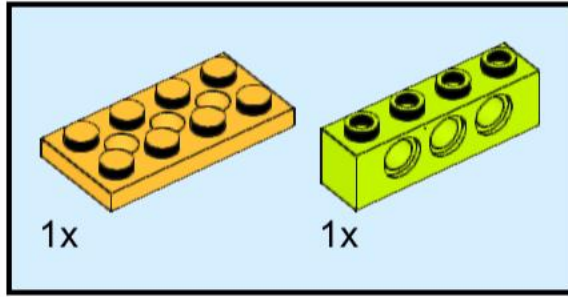

12

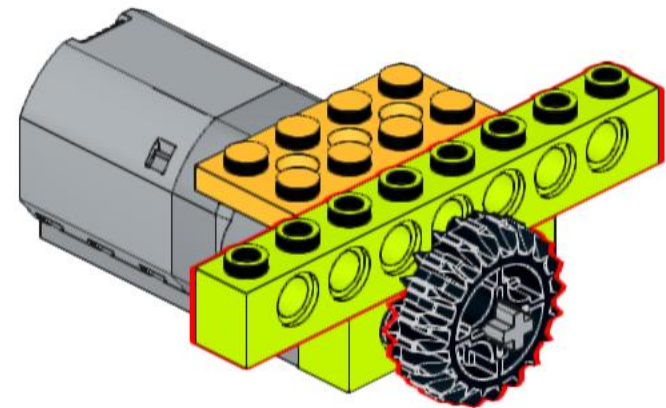
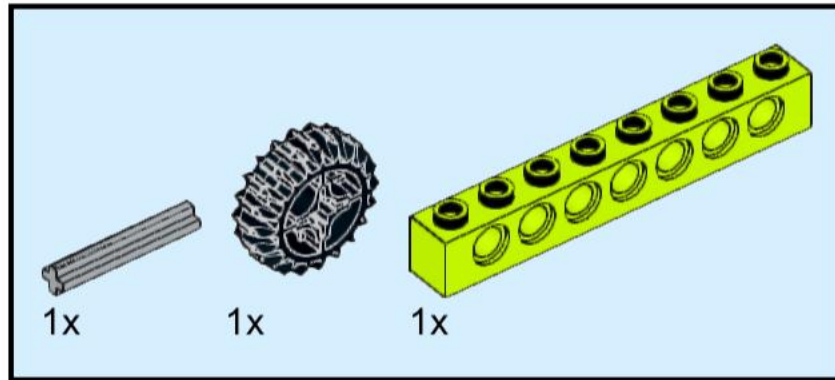

13

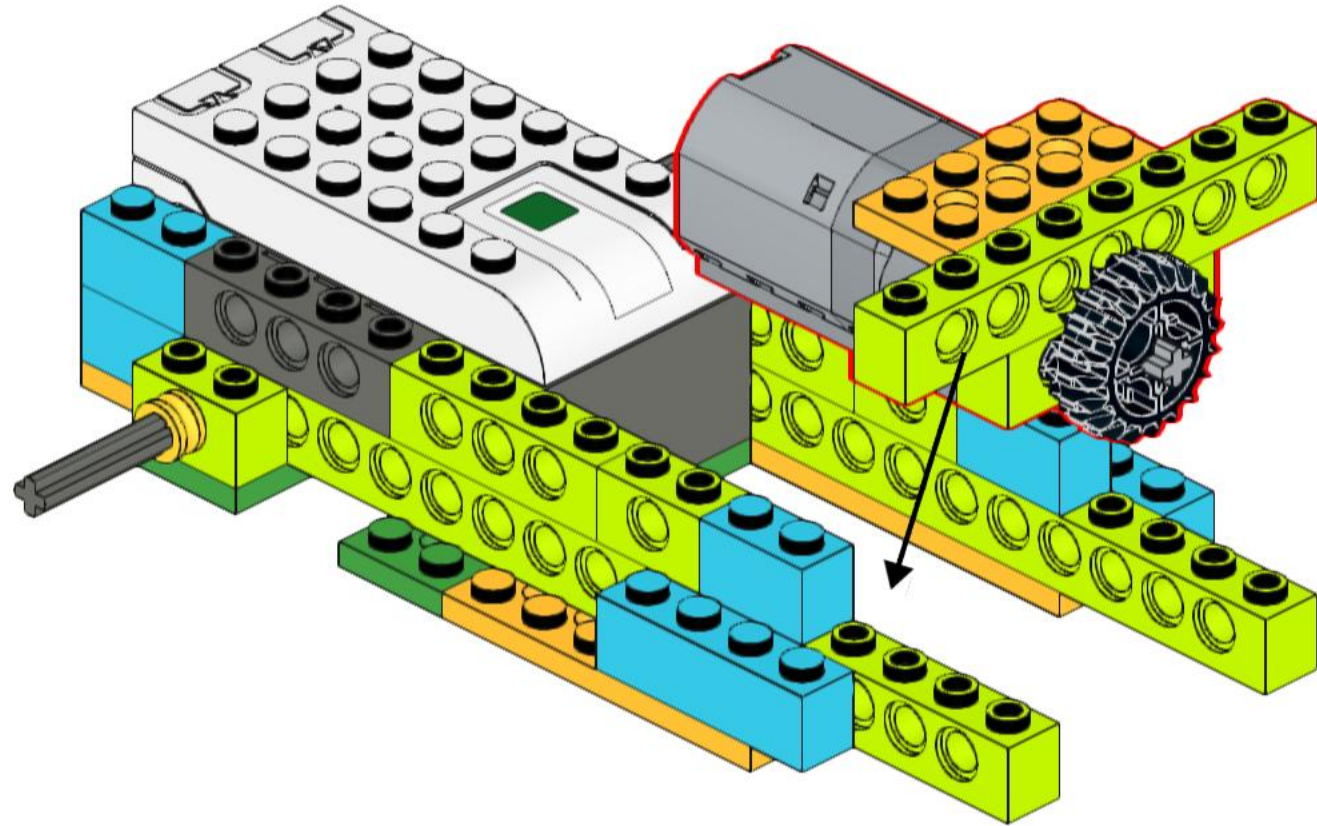

14

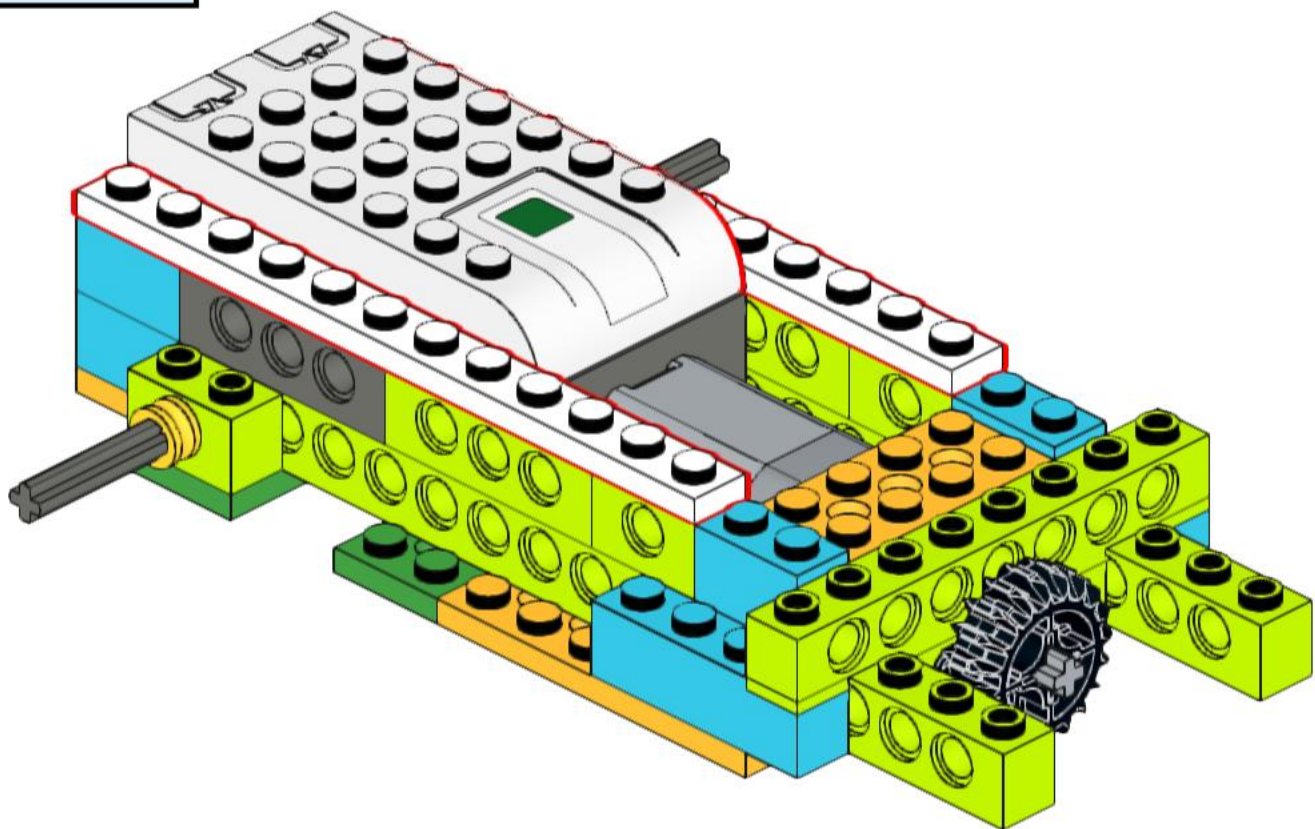
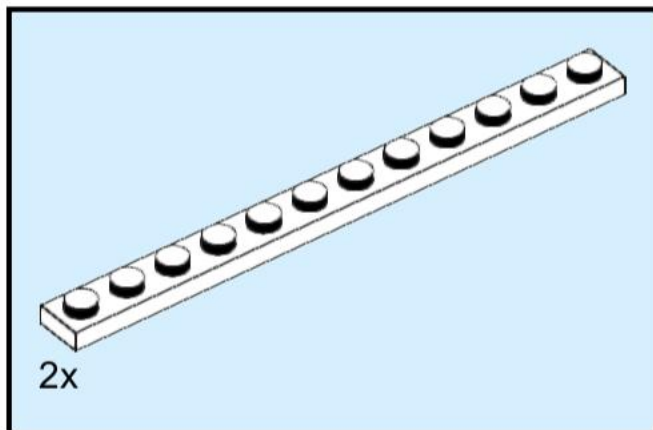

15

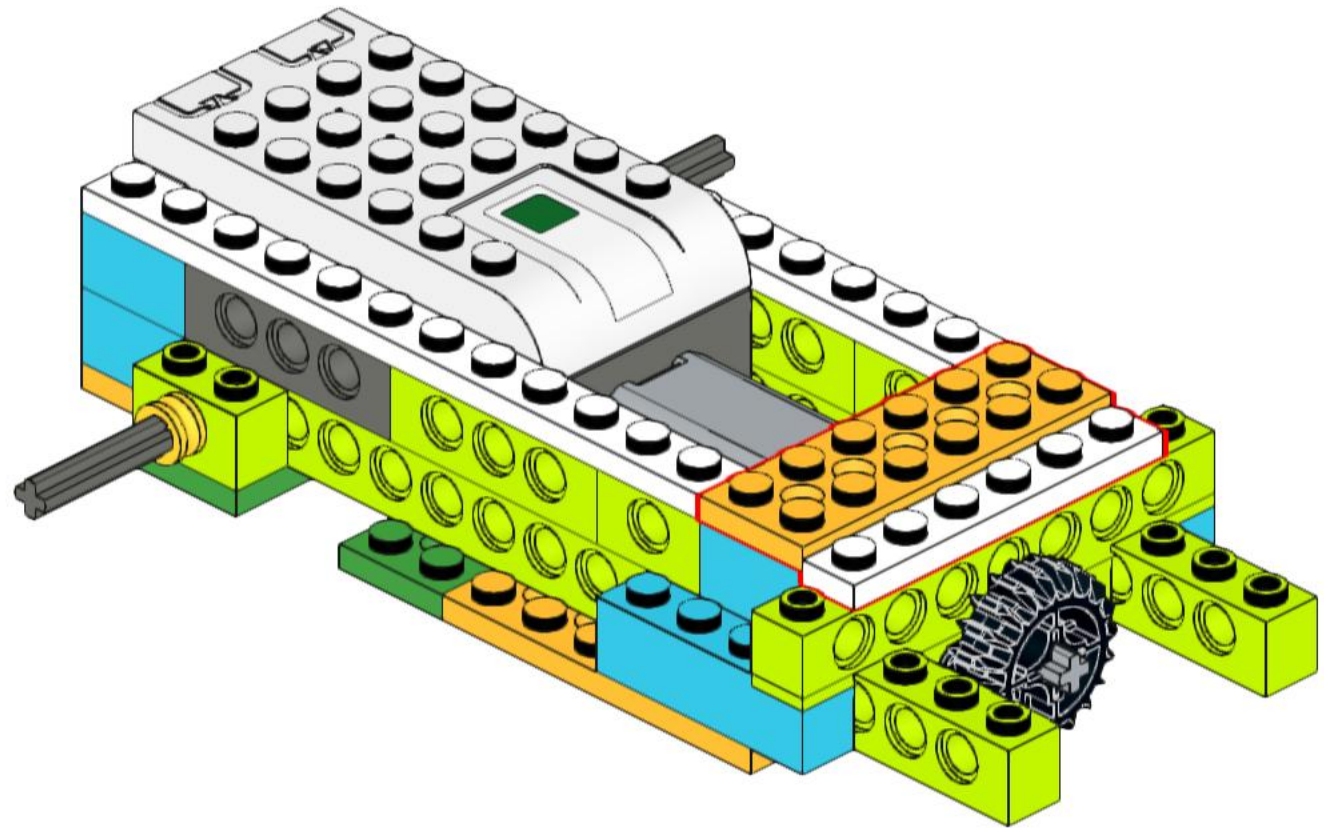
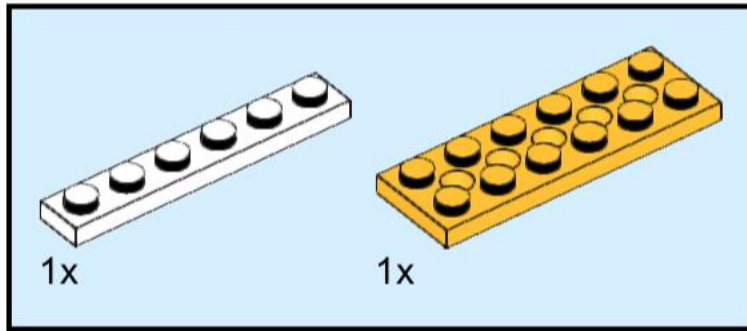

17

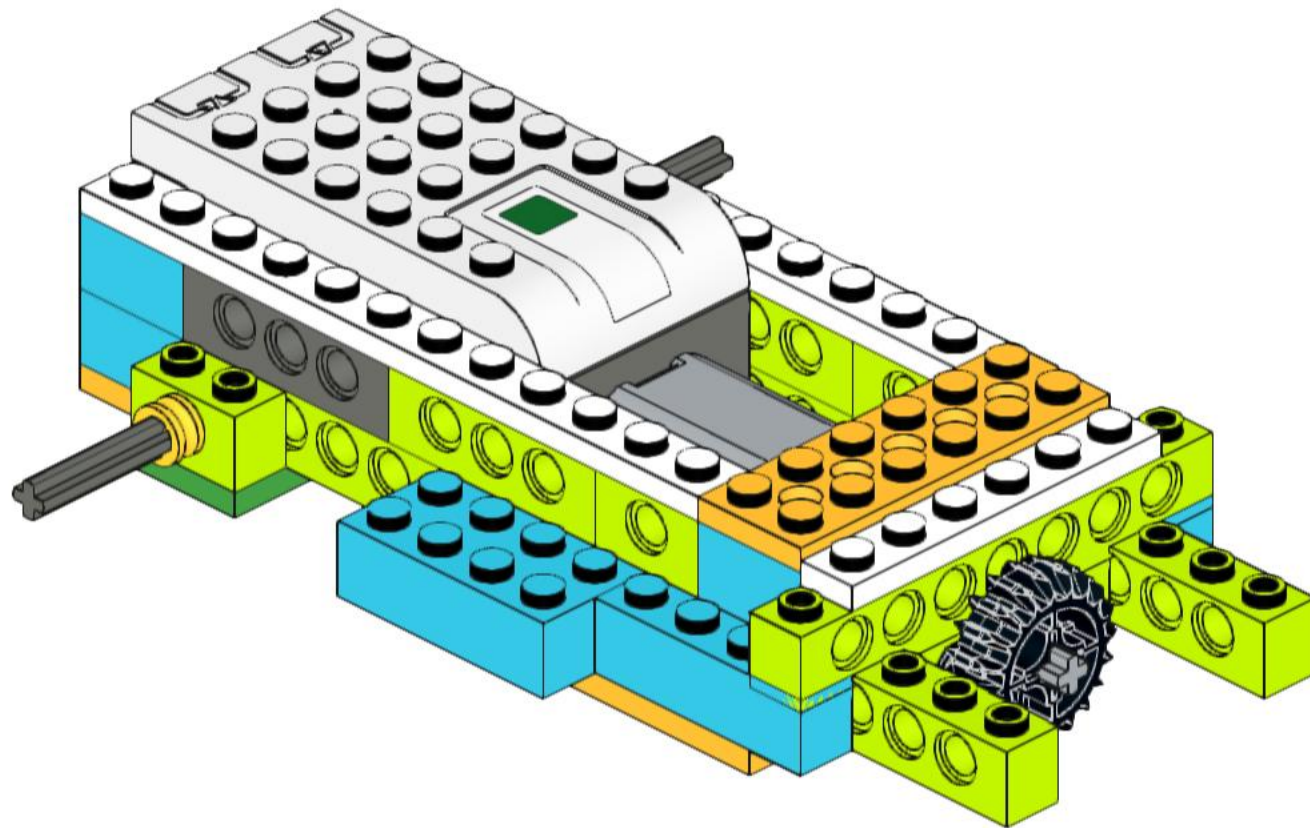

18

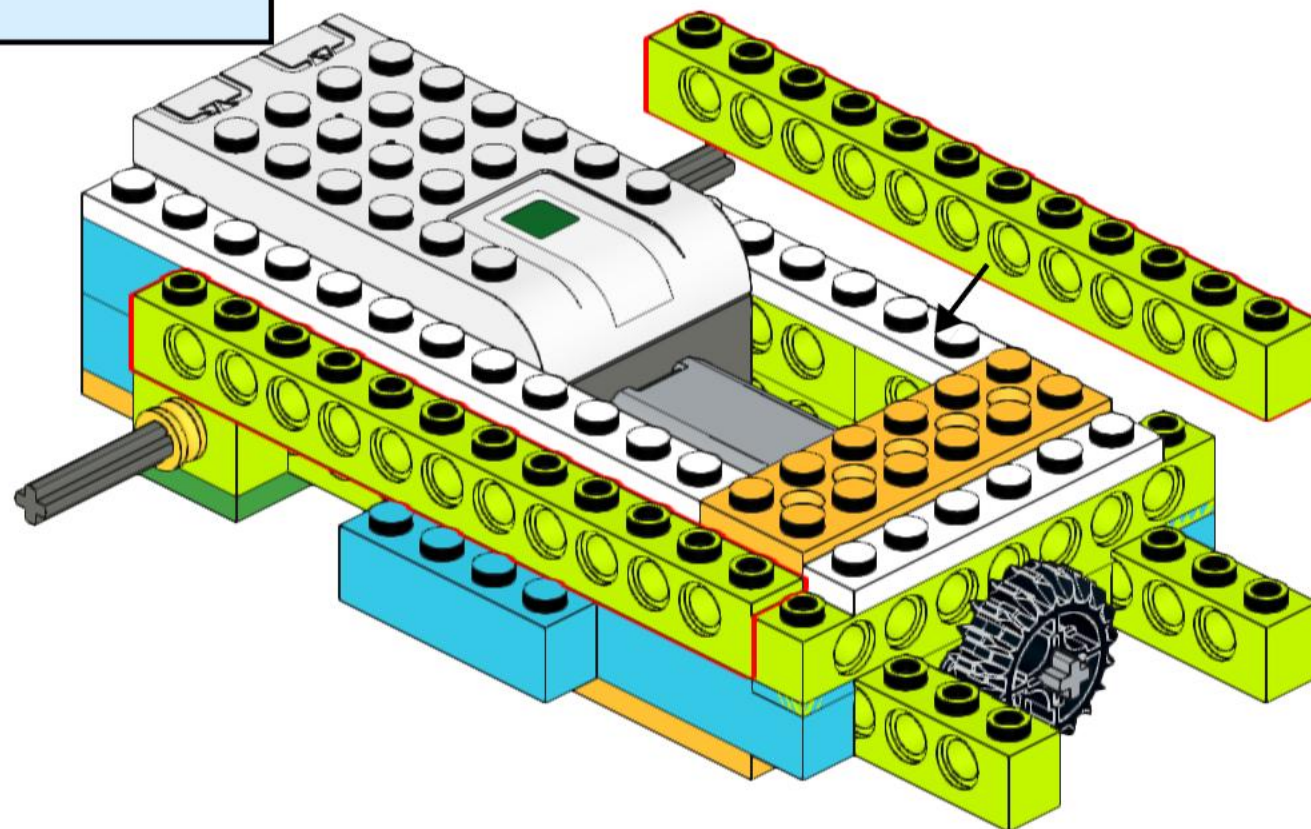
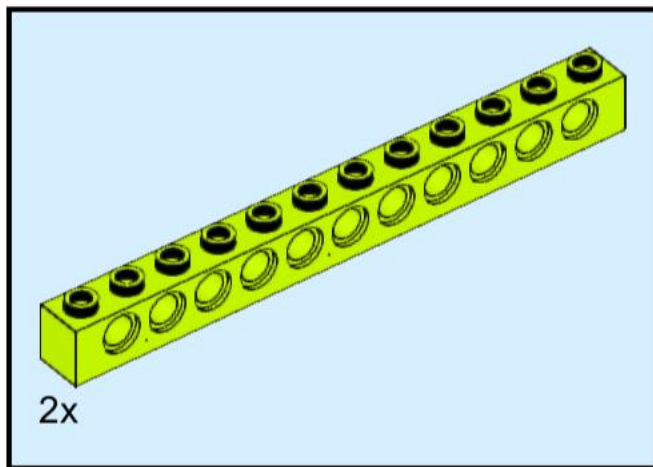

19

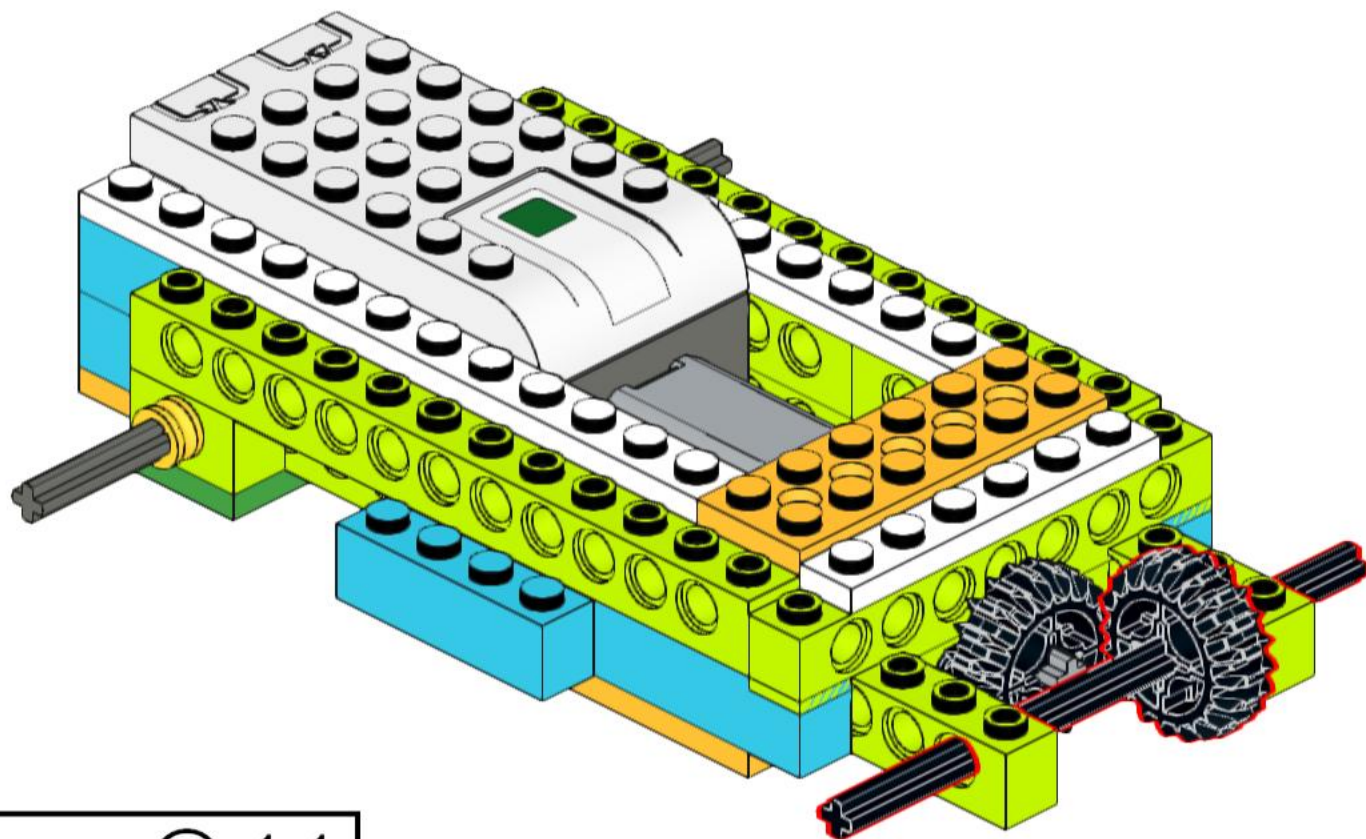
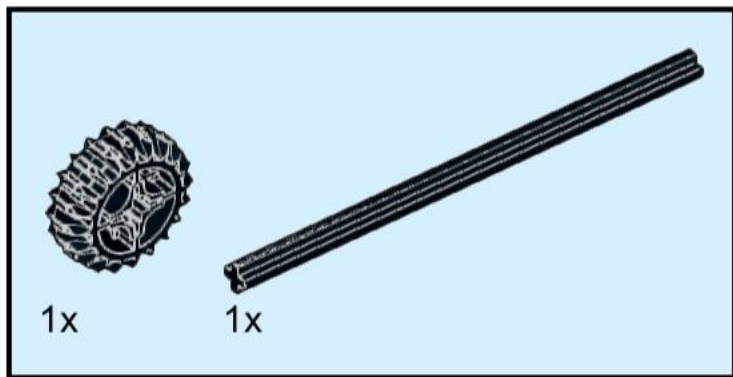

20

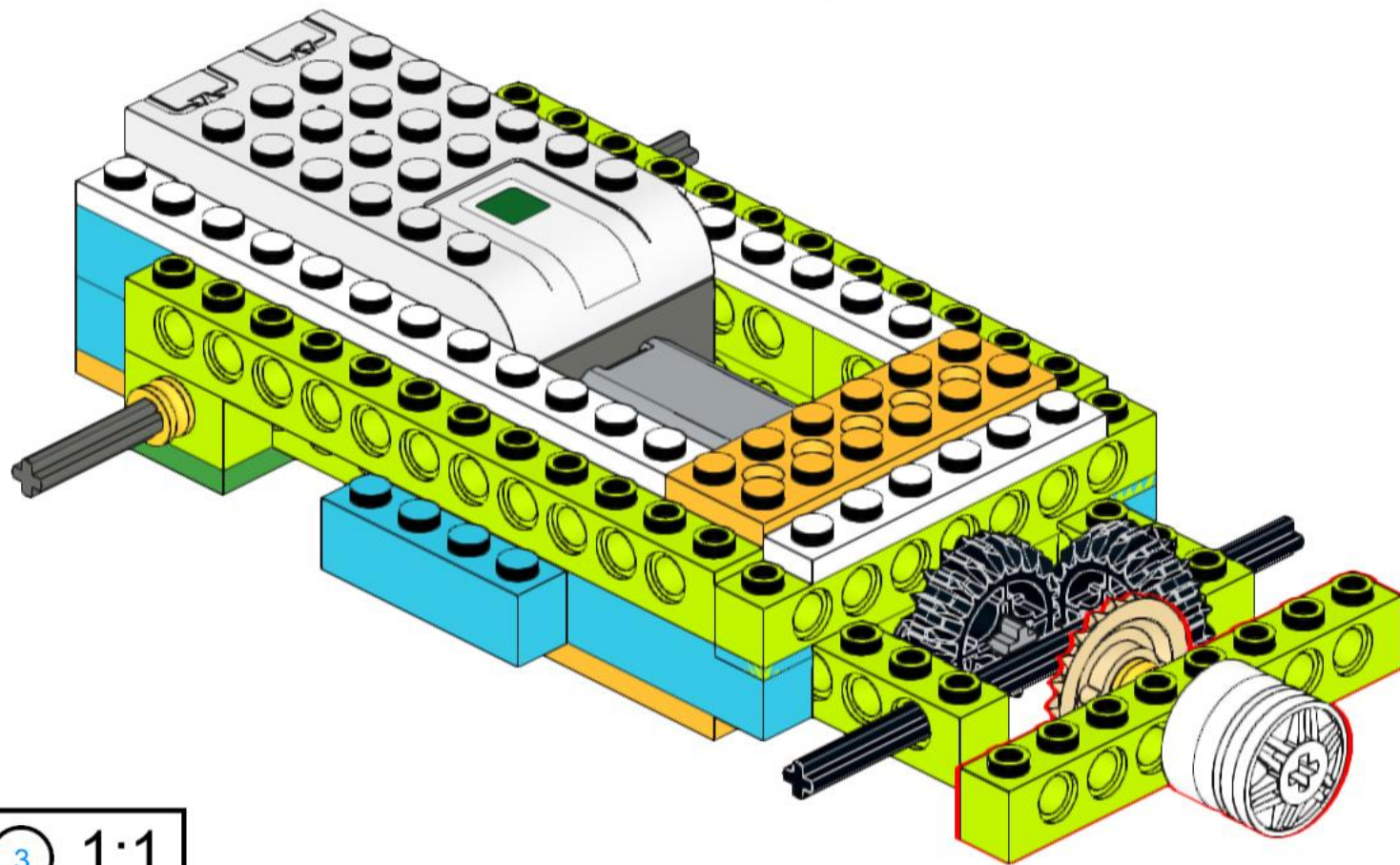
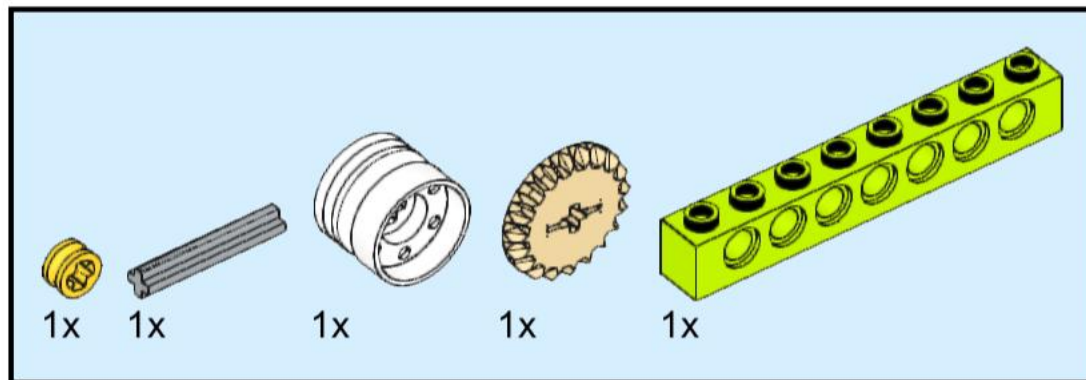

21

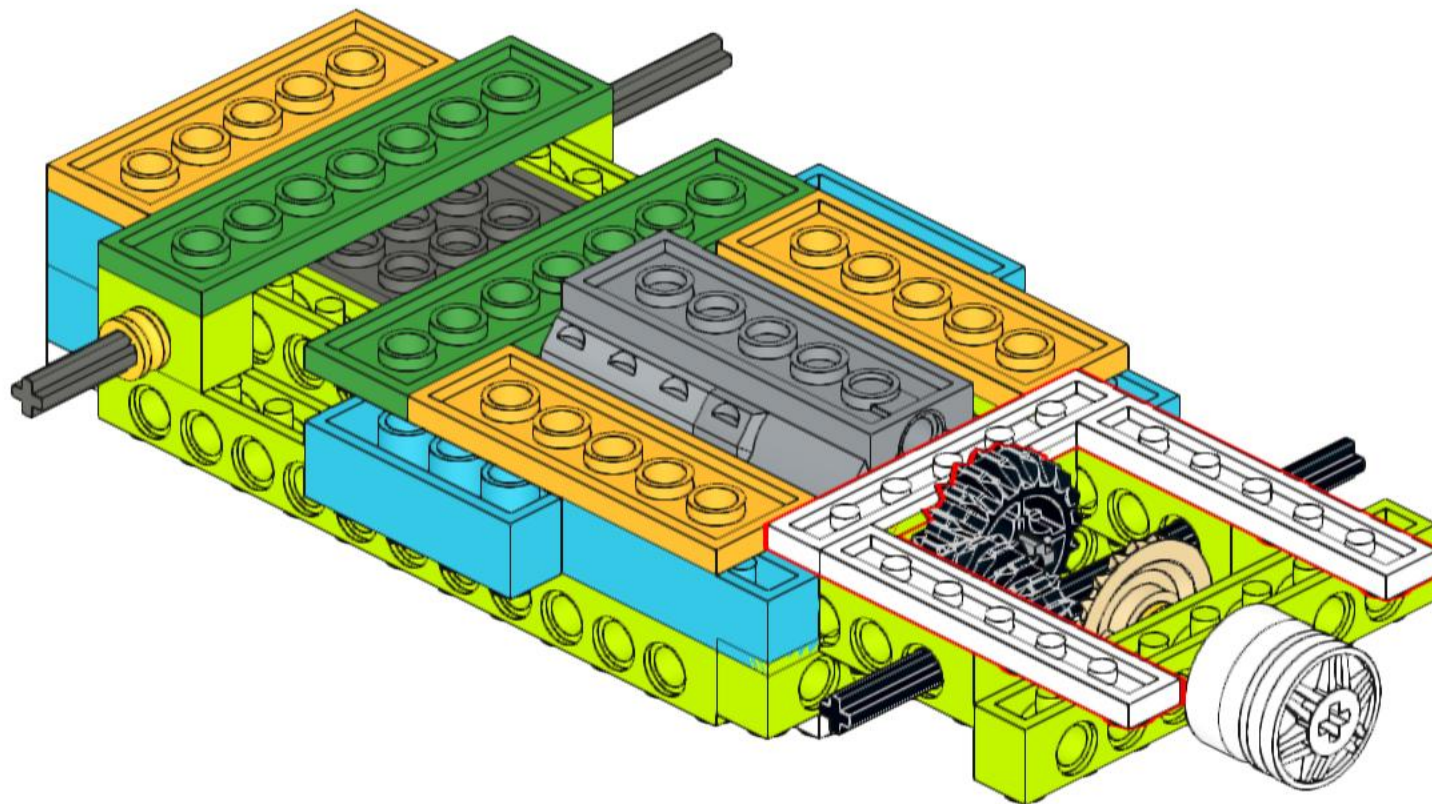
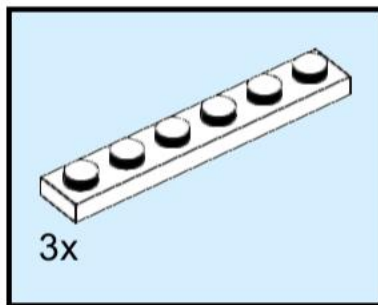

22

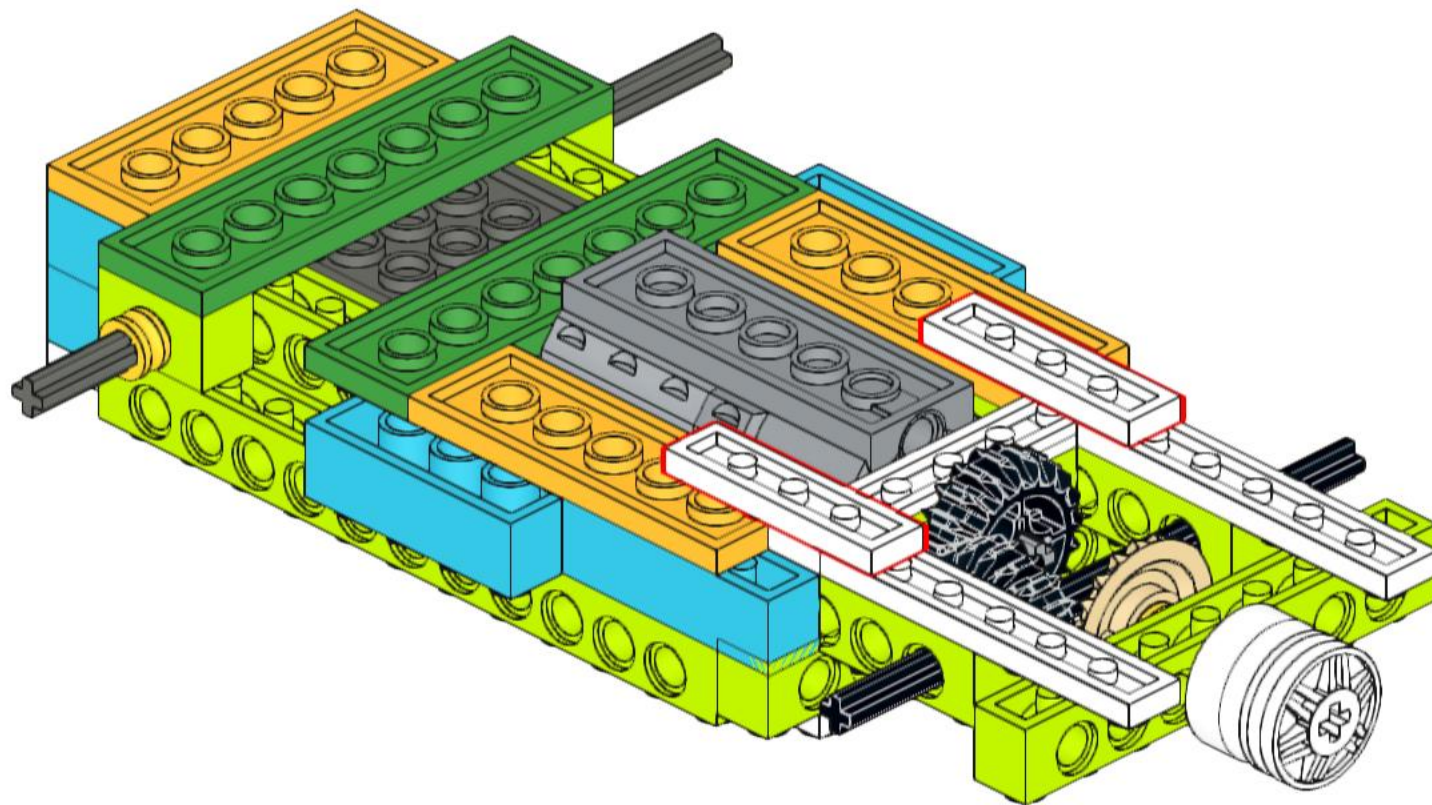
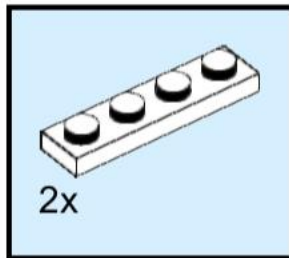

23

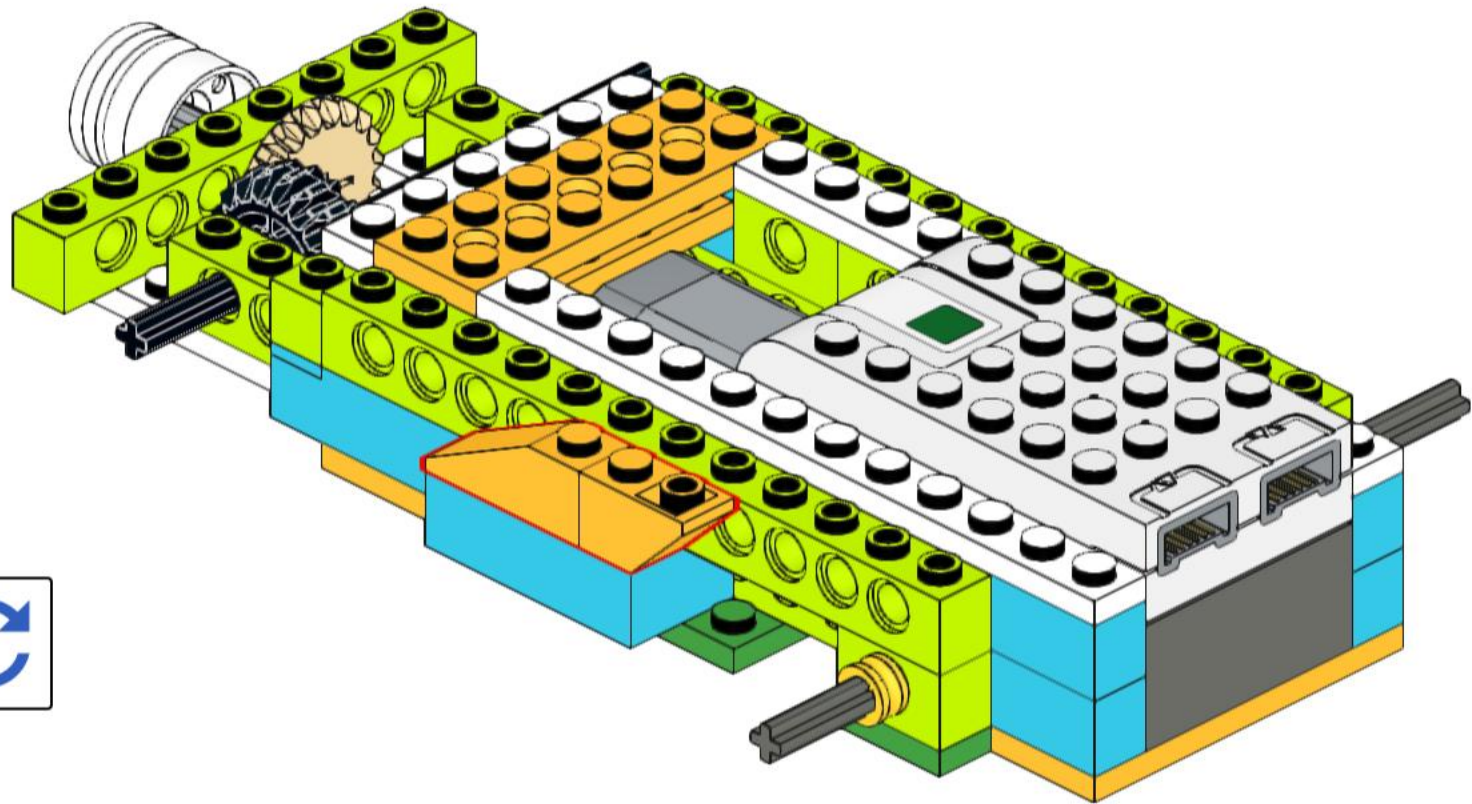
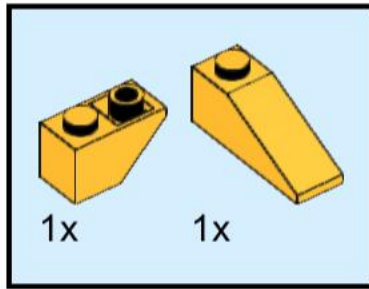

24

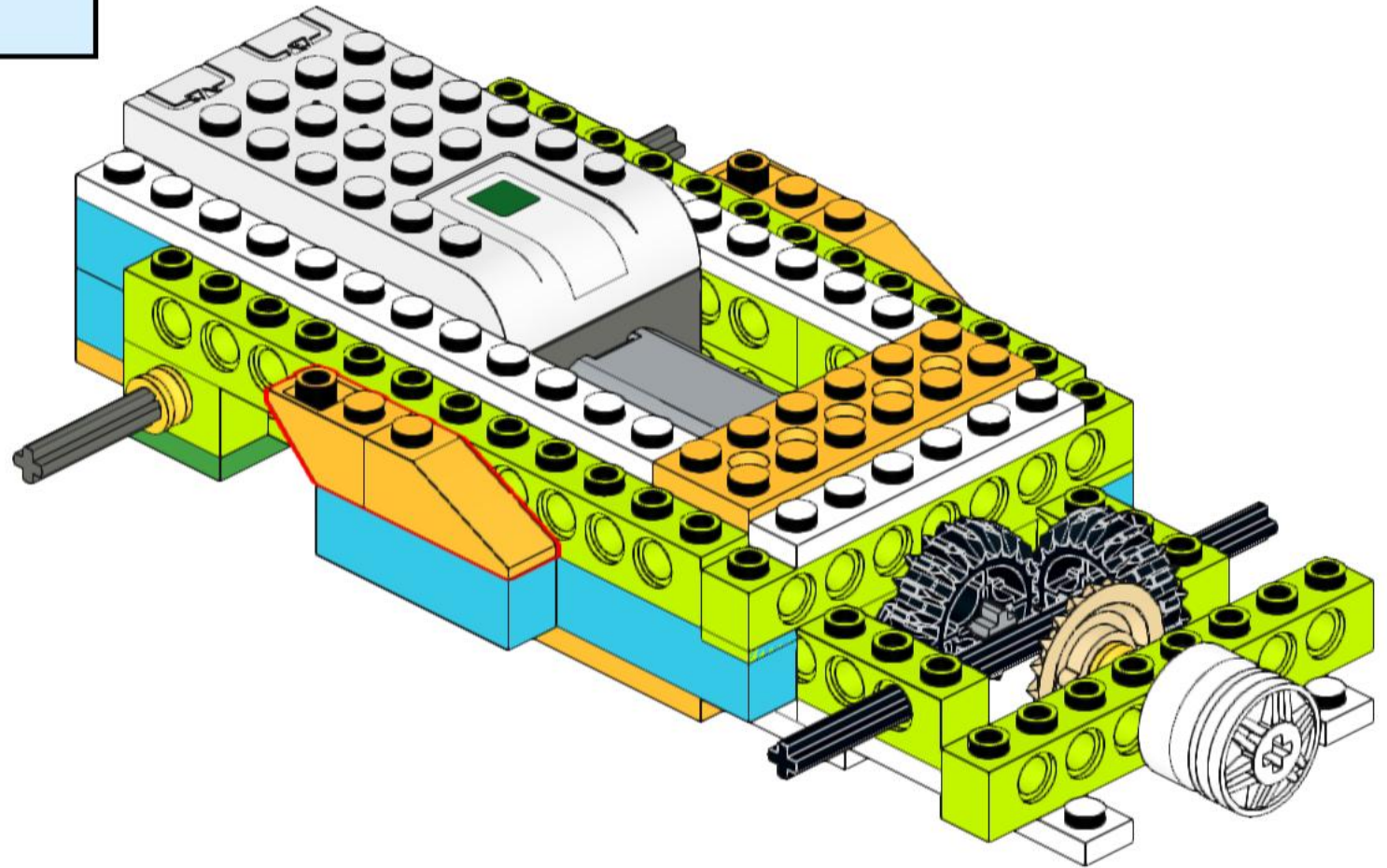
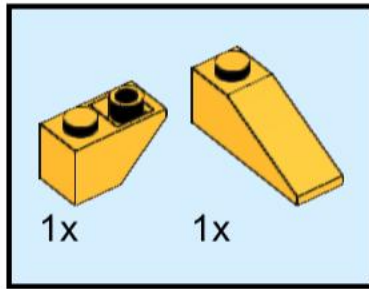

25

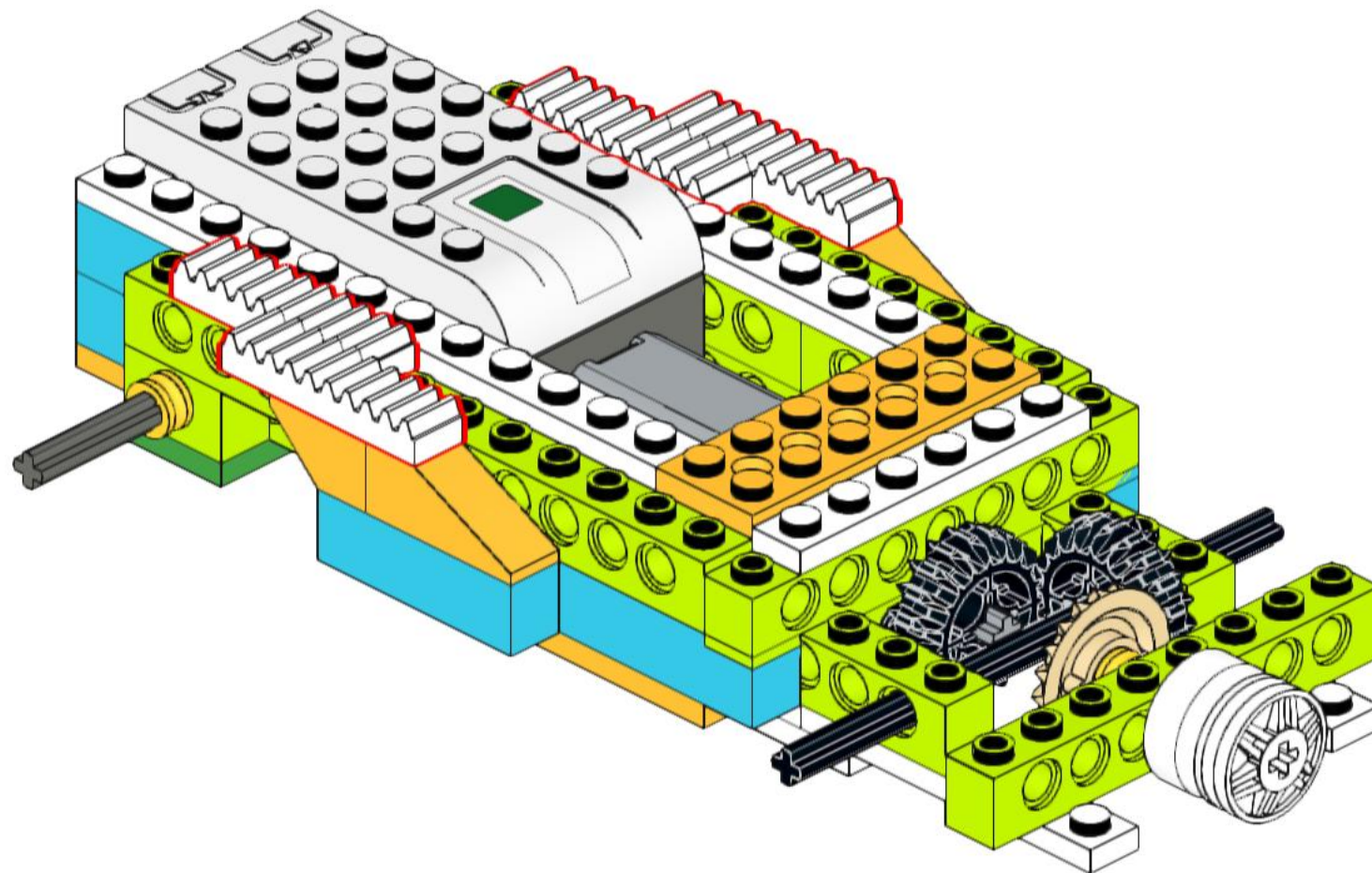
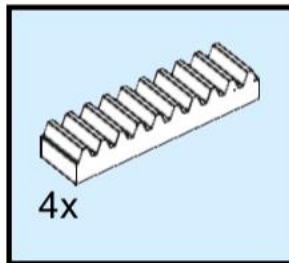

26

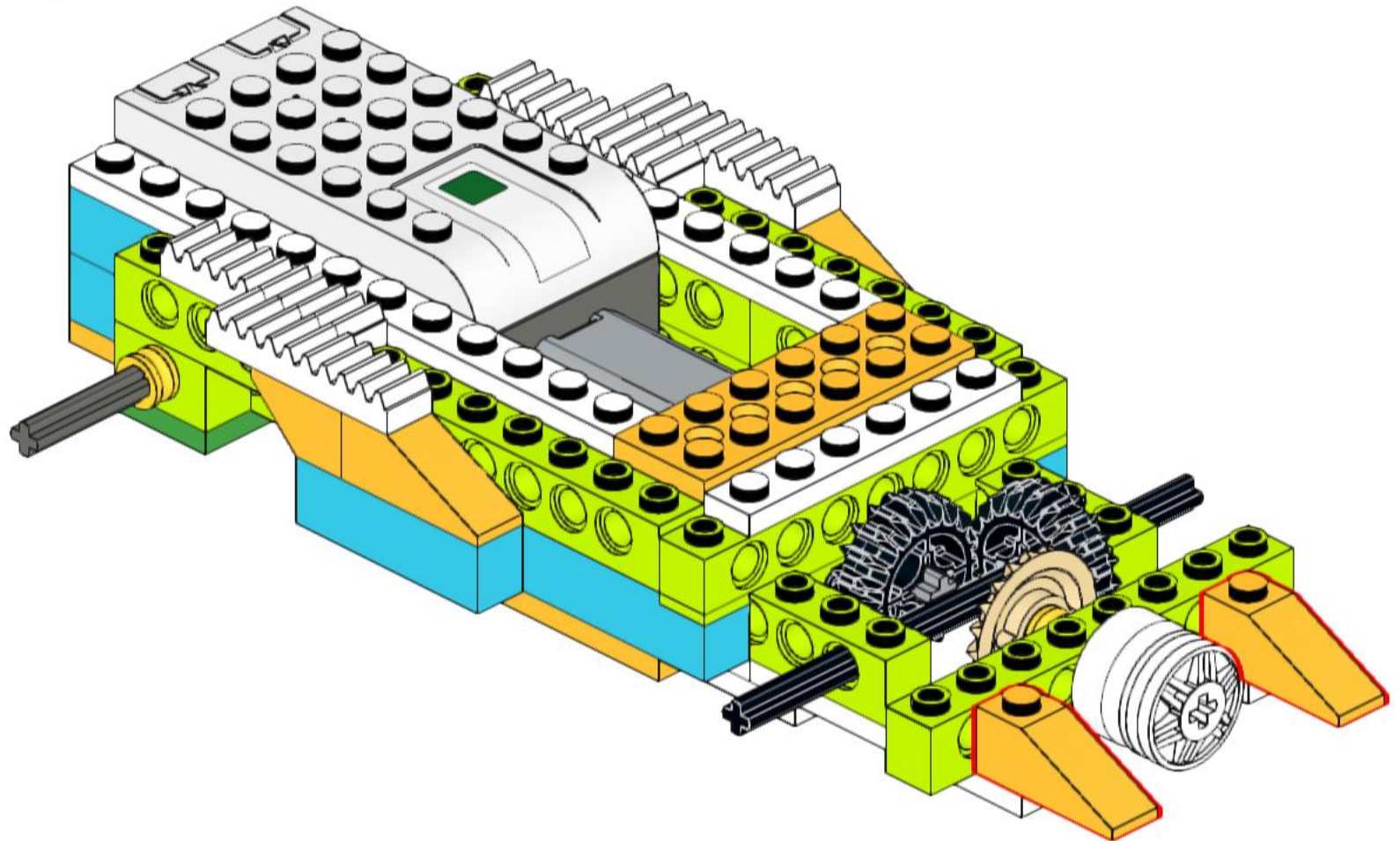
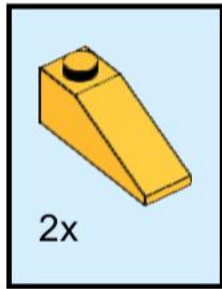

27

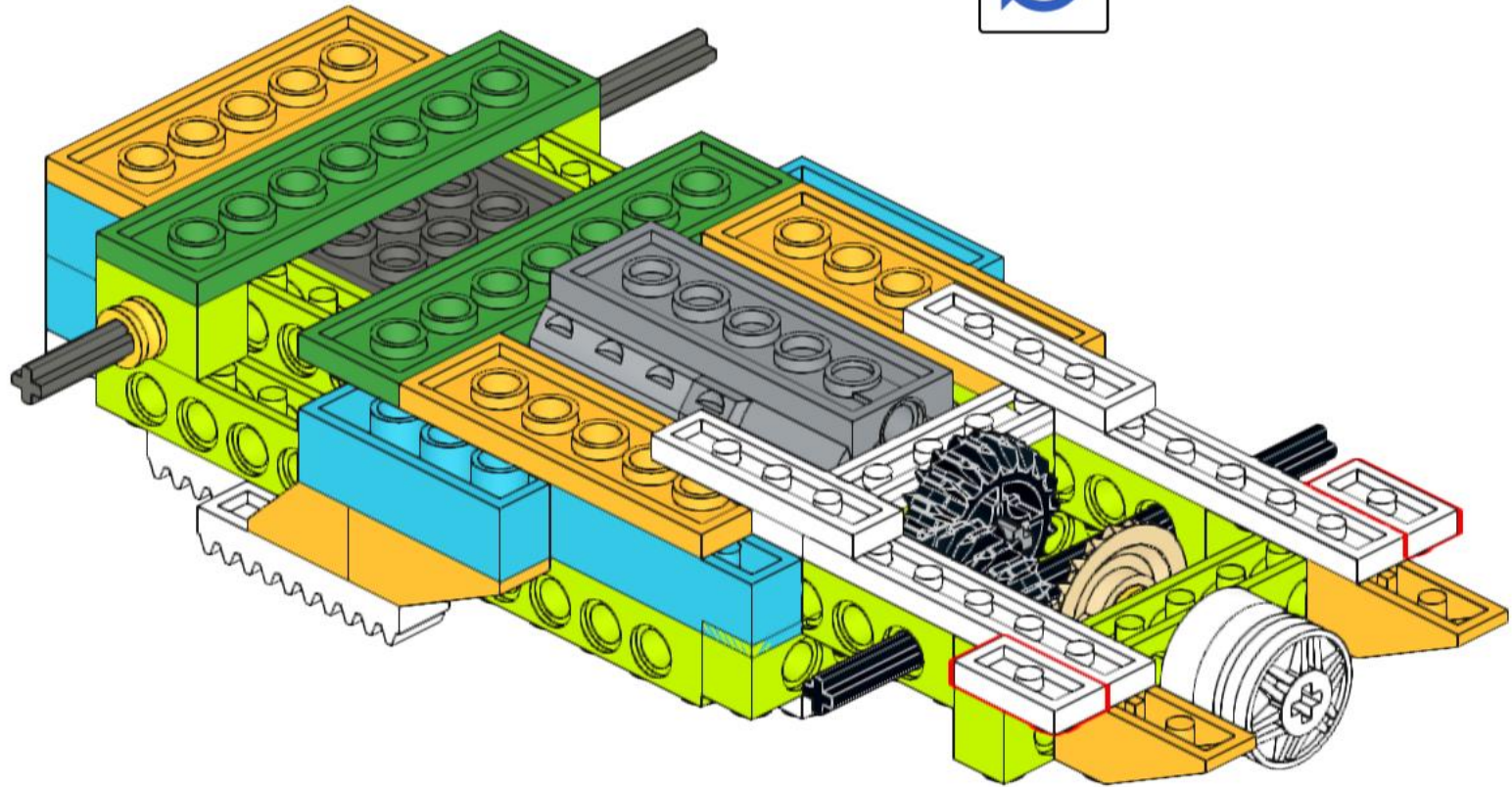
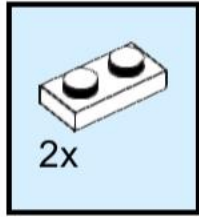

28

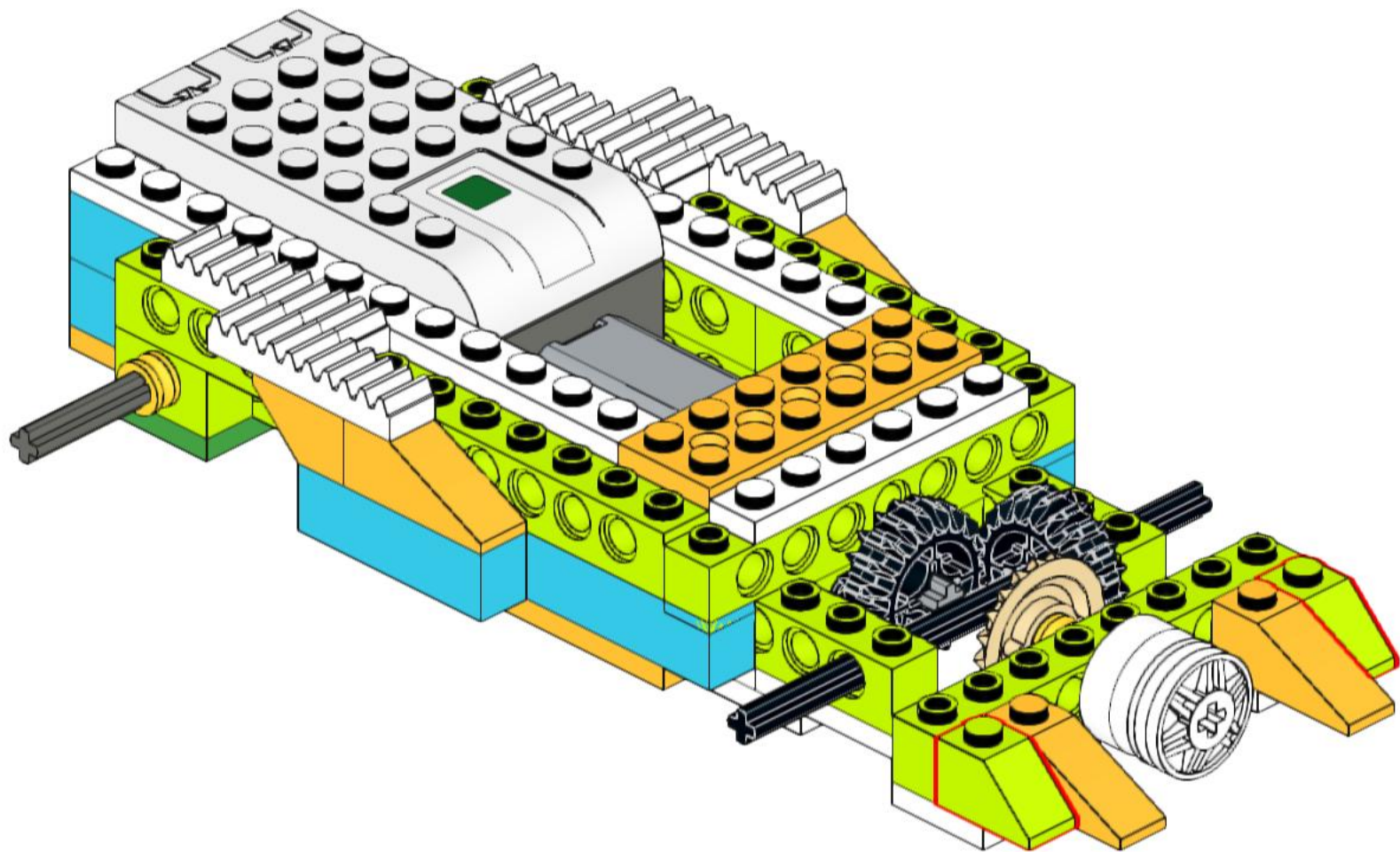
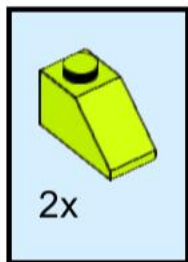

29

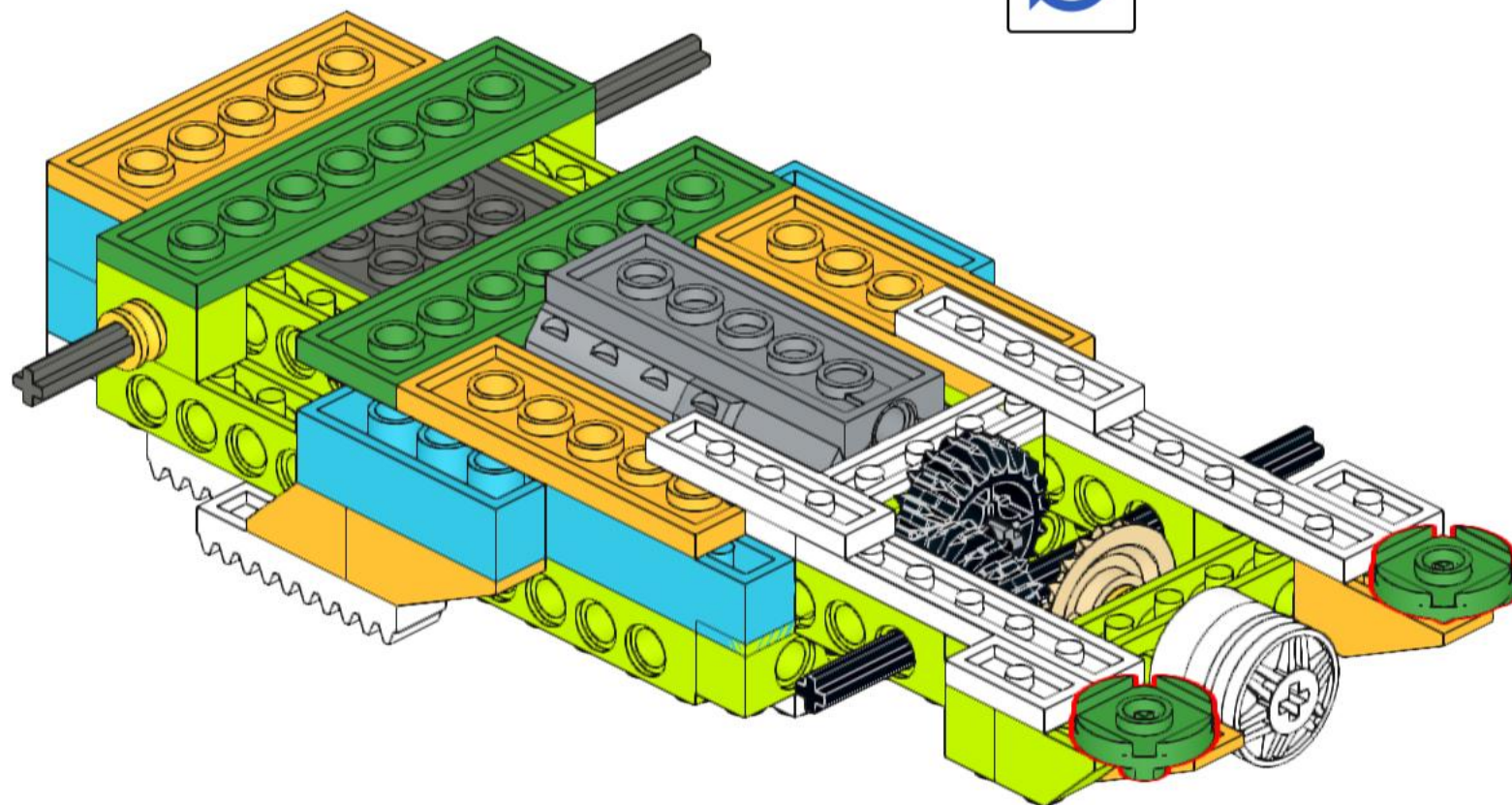
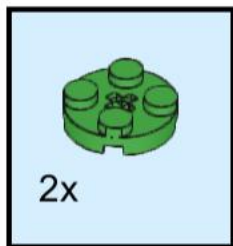

30

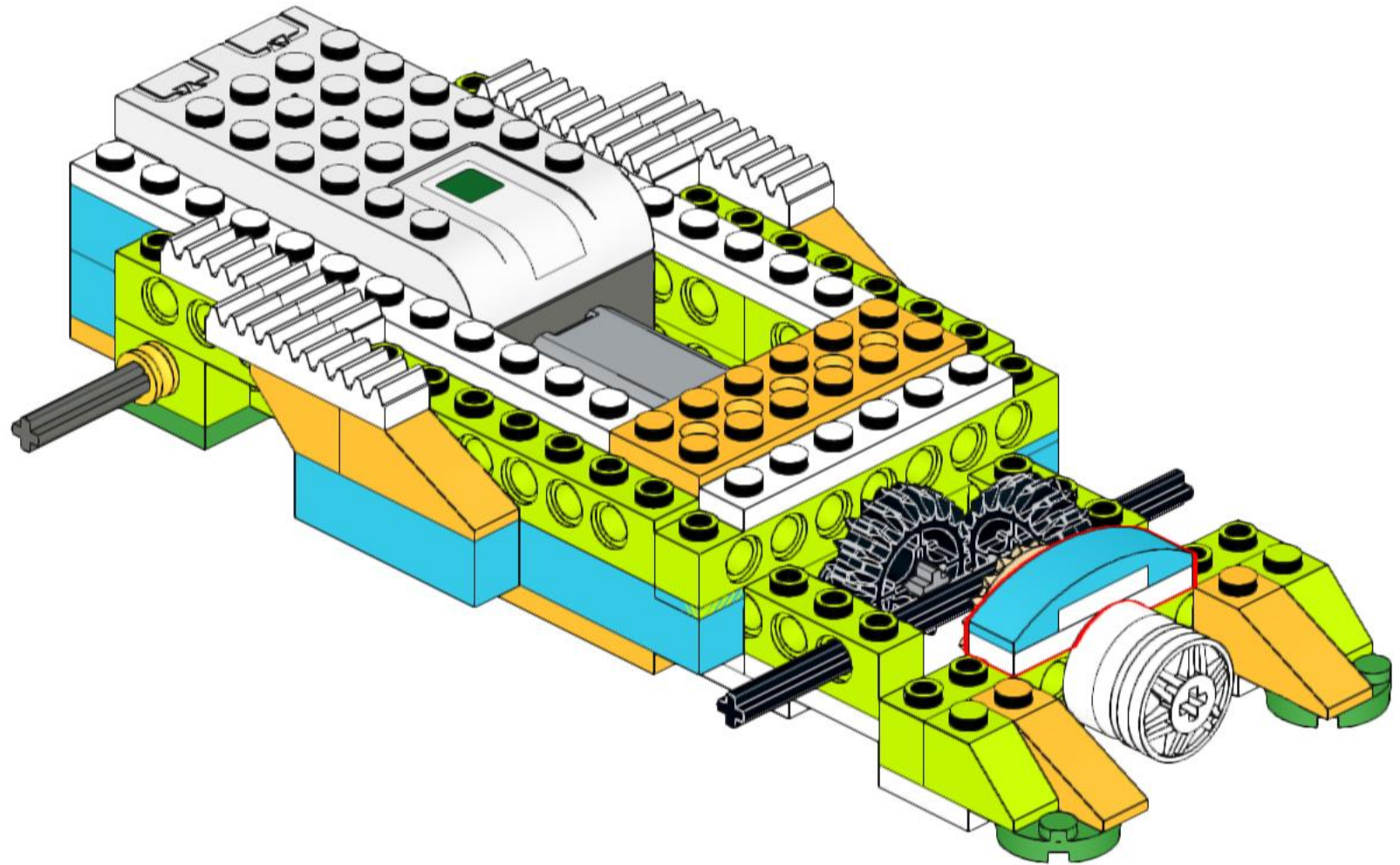
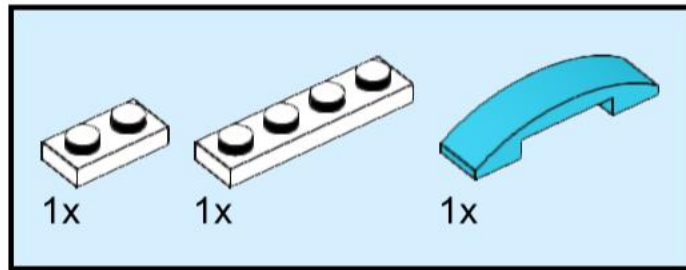

31

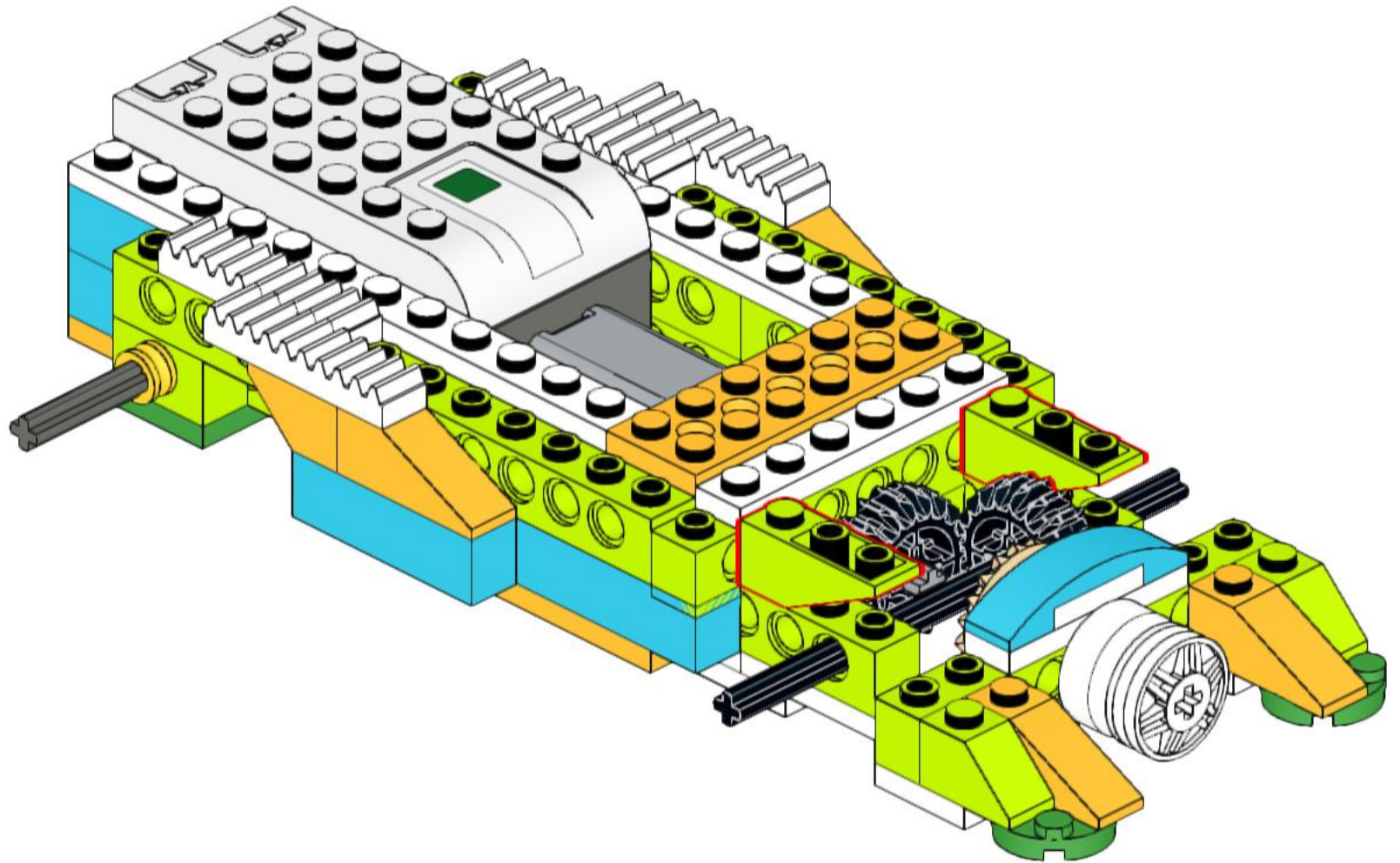
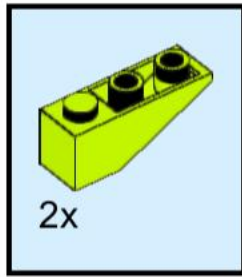

32

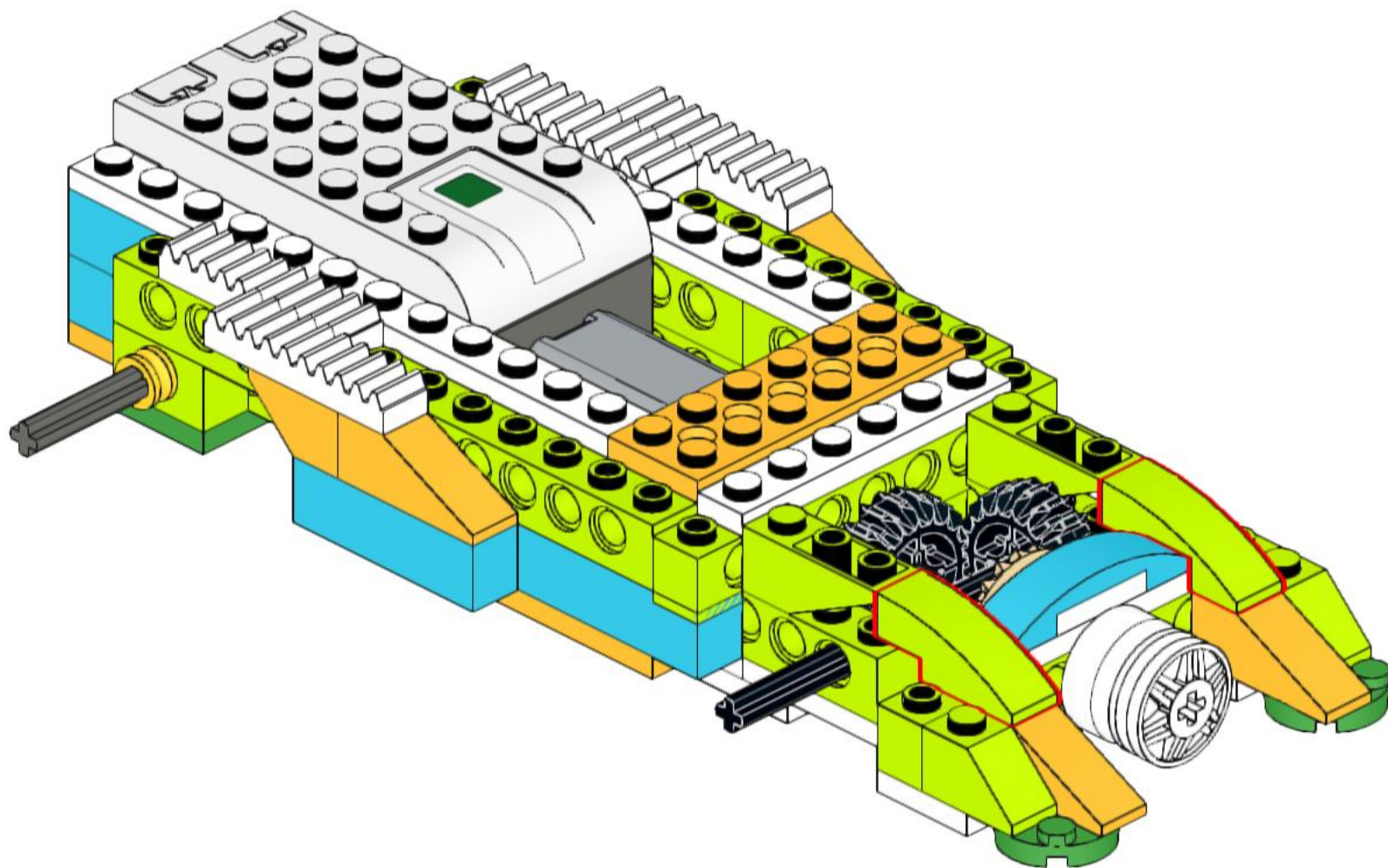
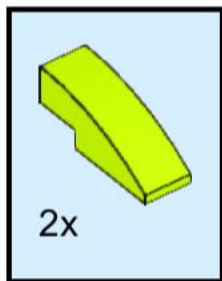

33

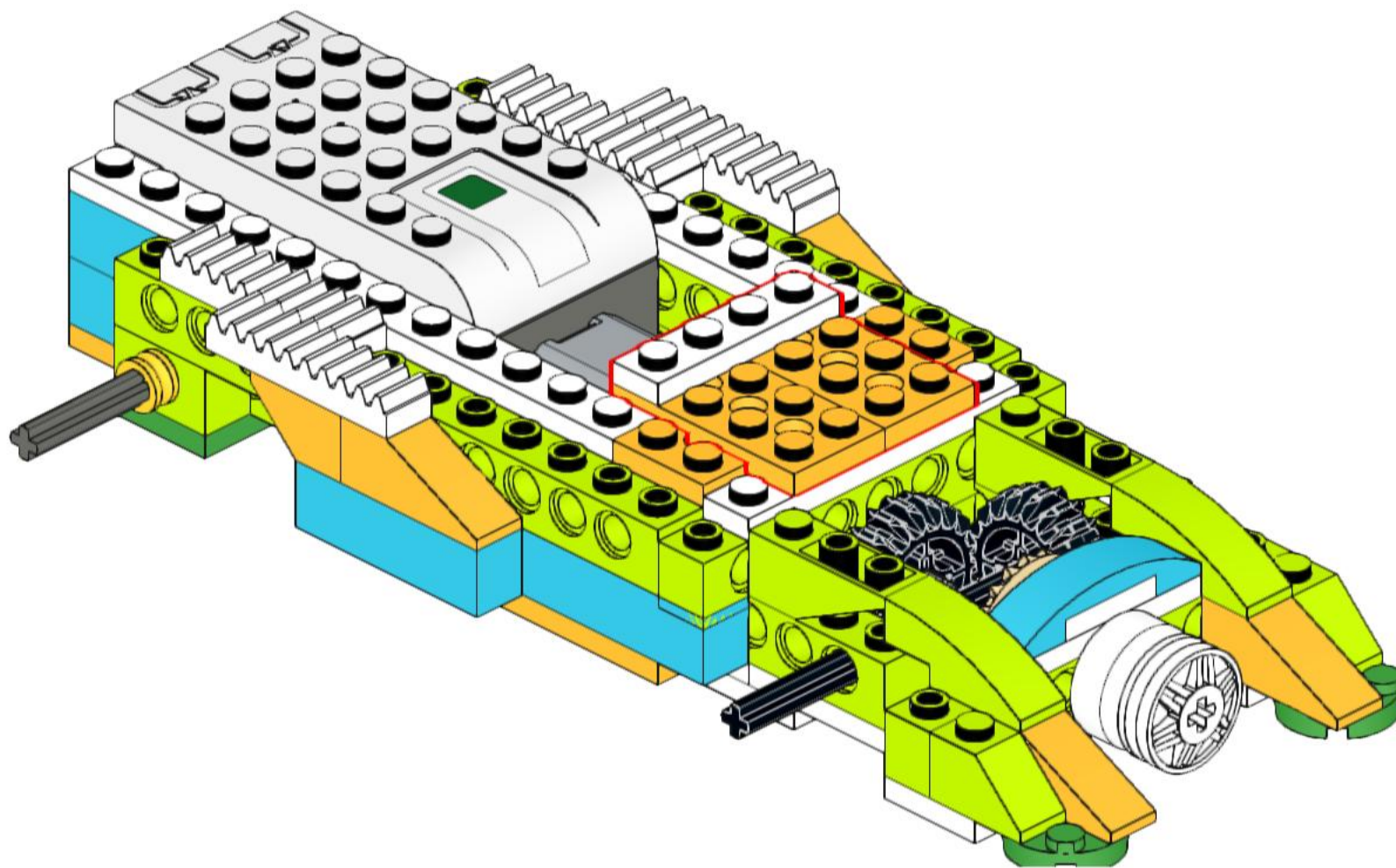
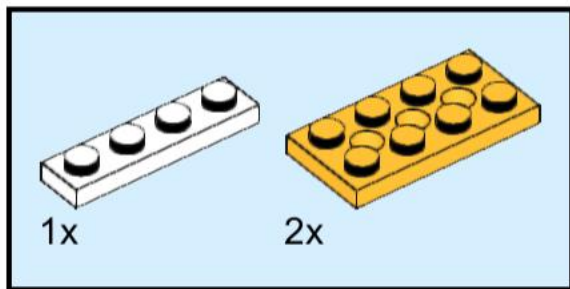

34

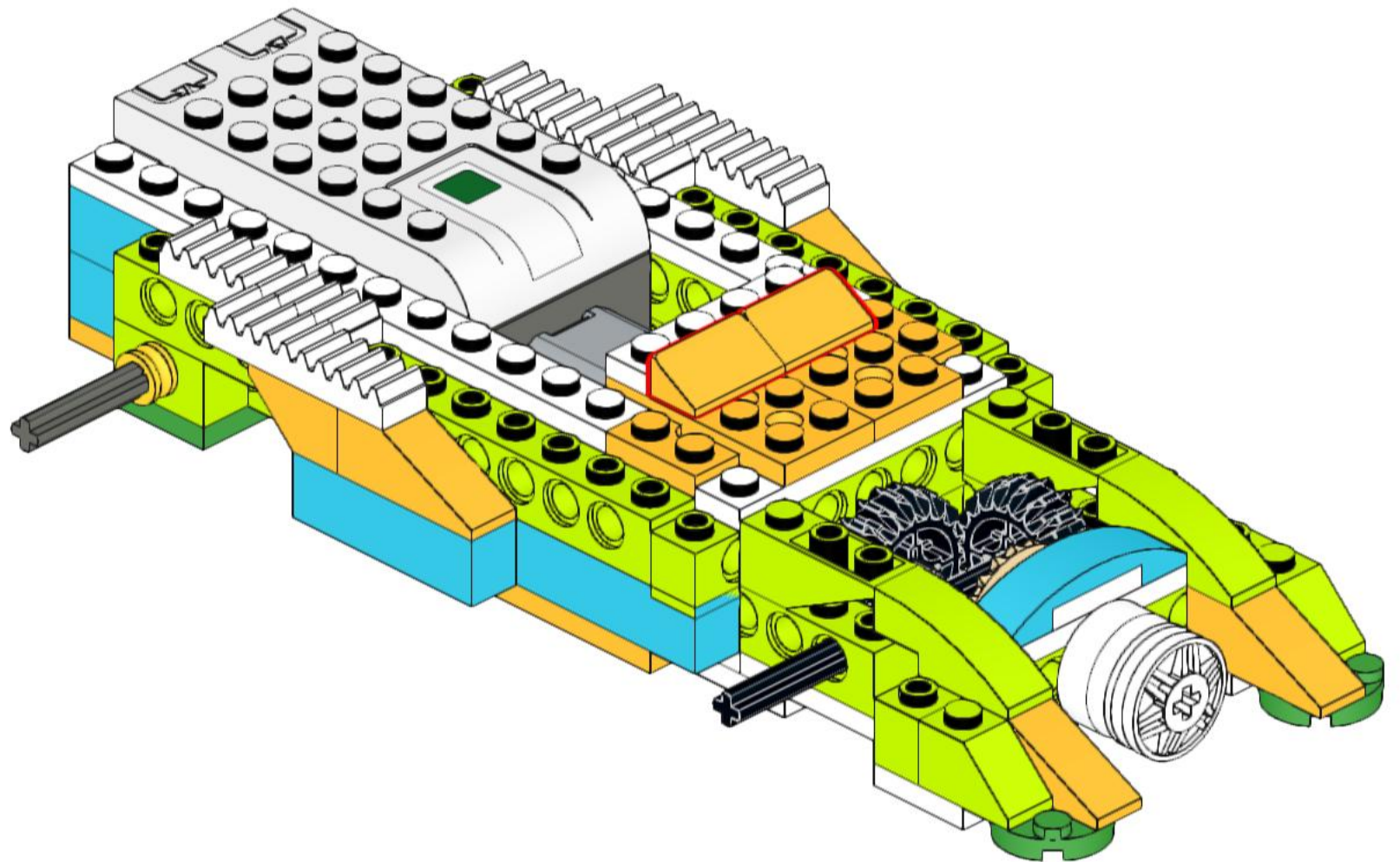
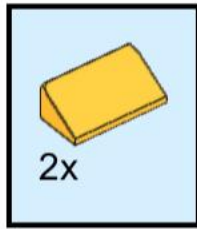

35

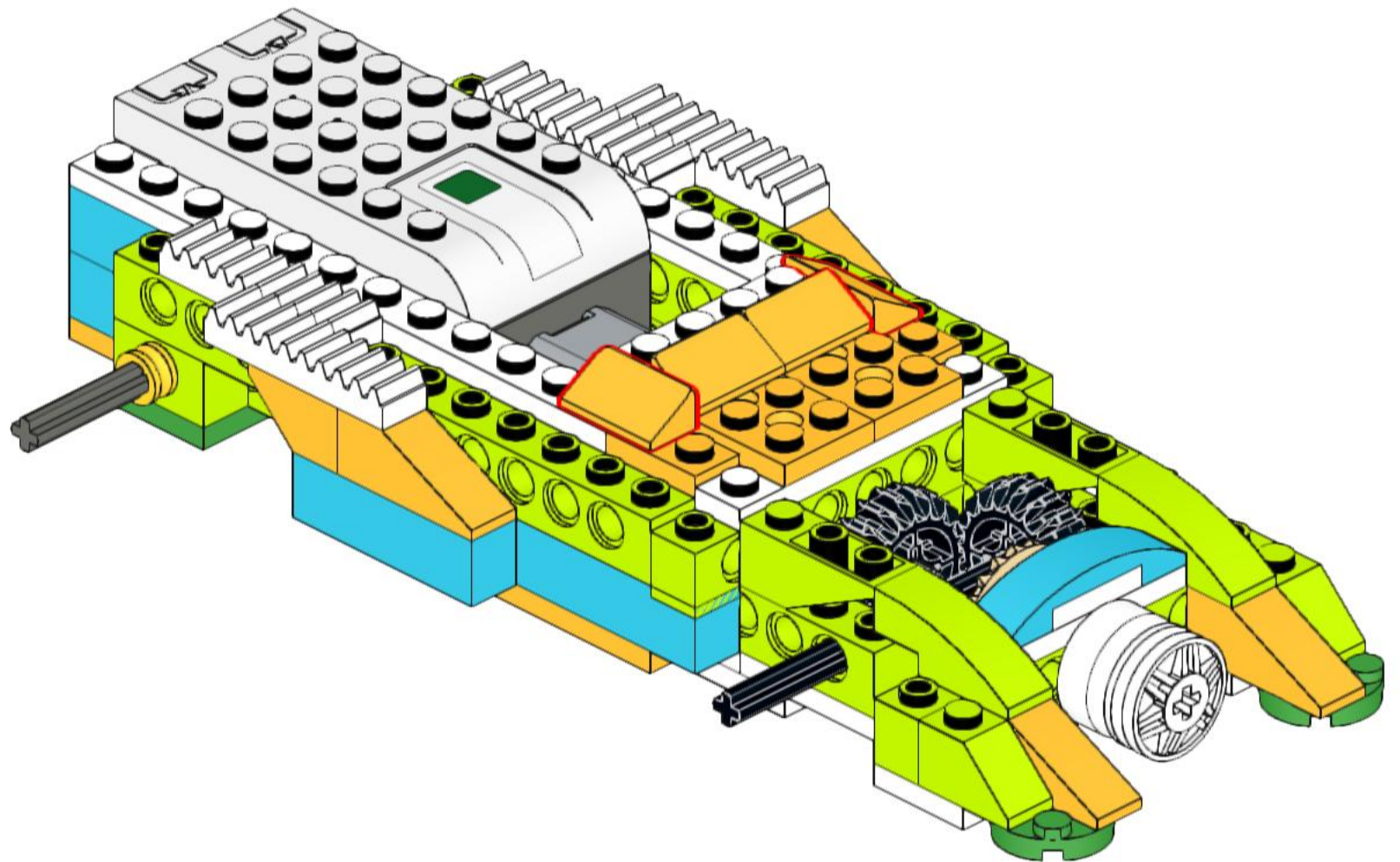
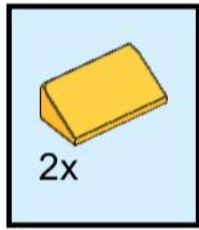

36

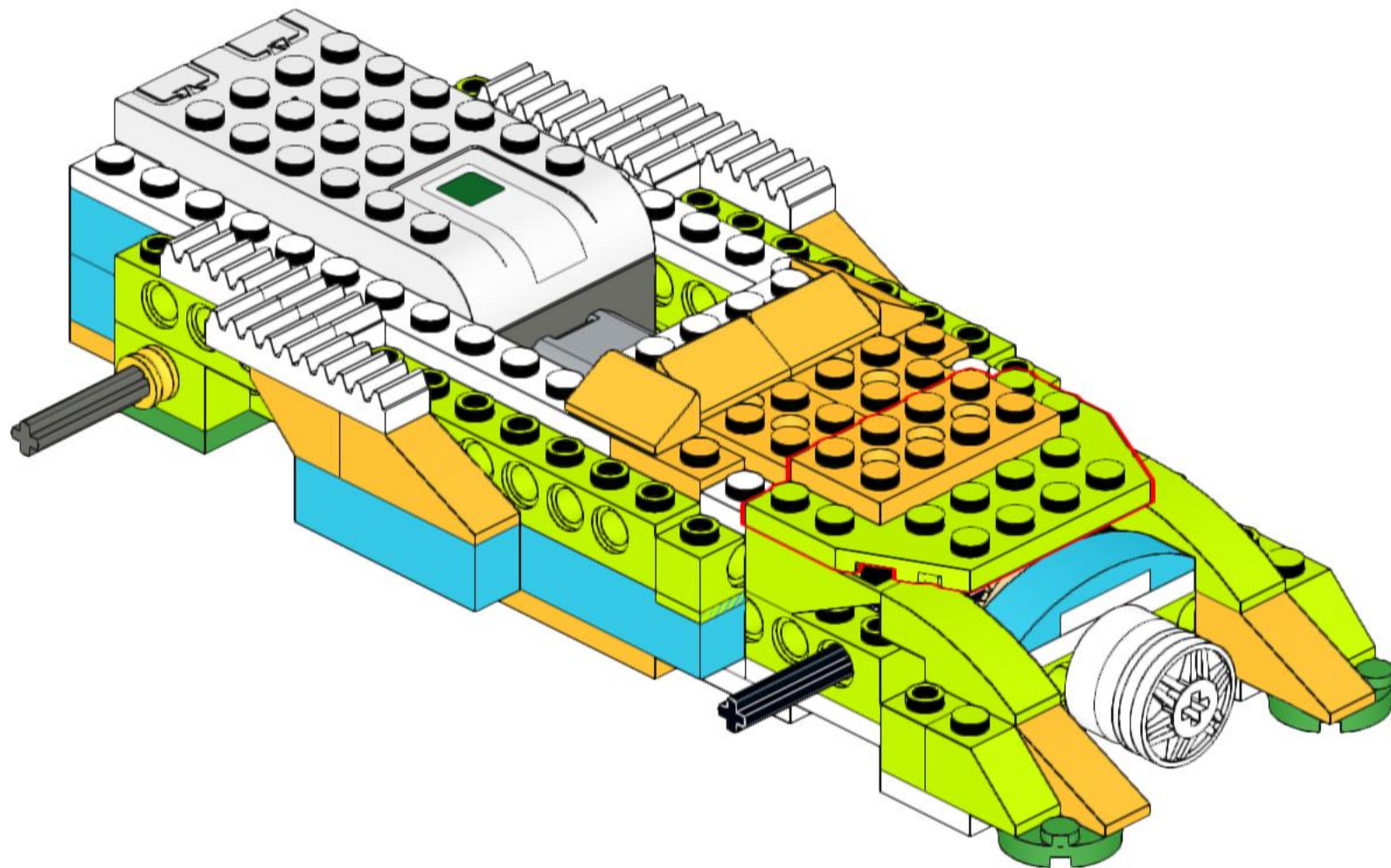
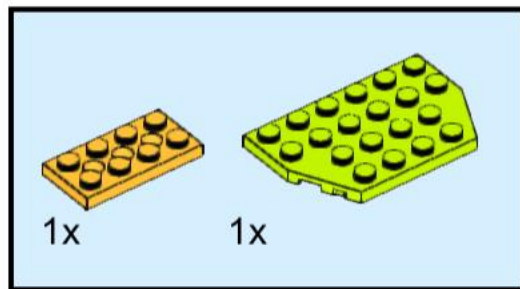

37

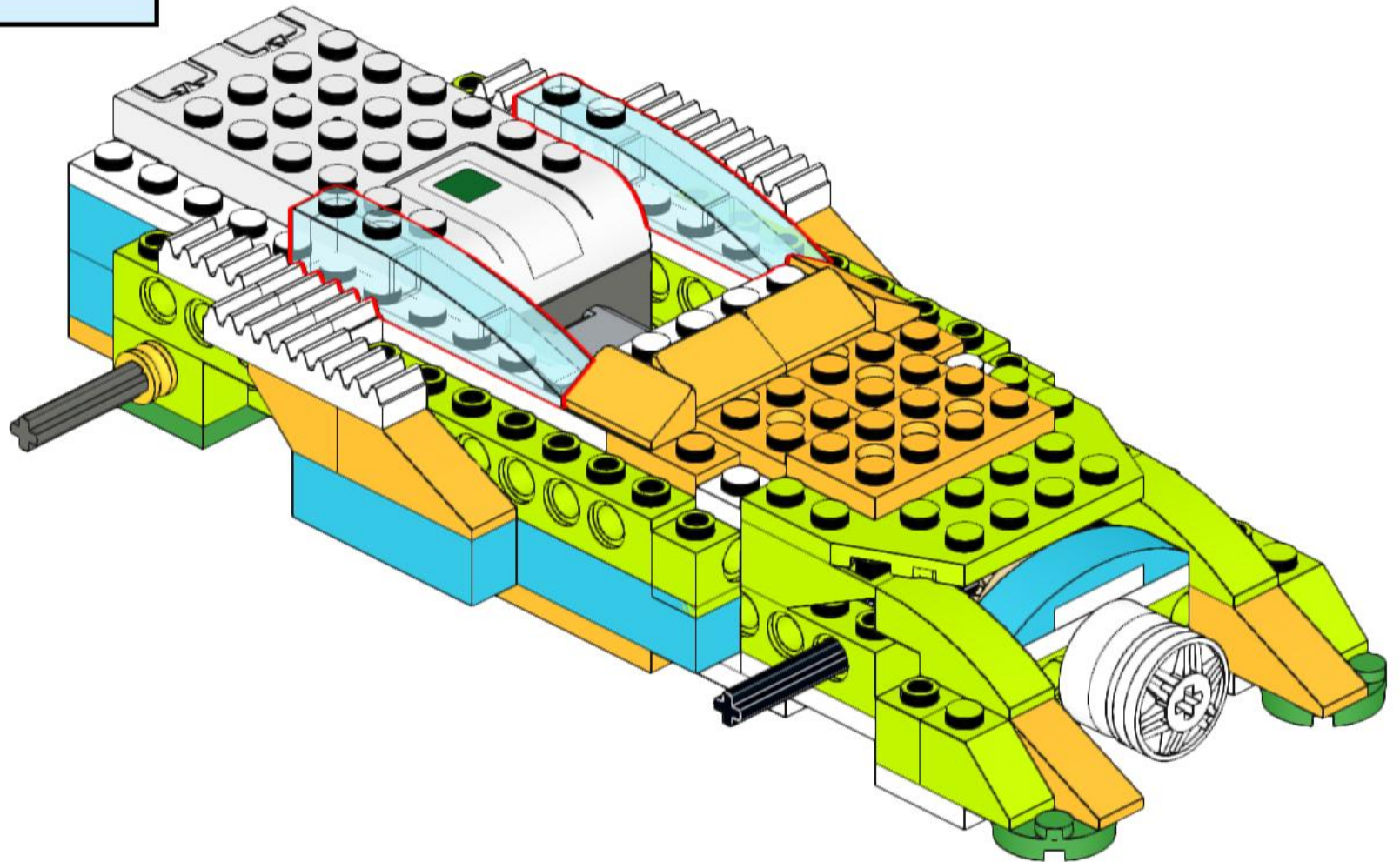
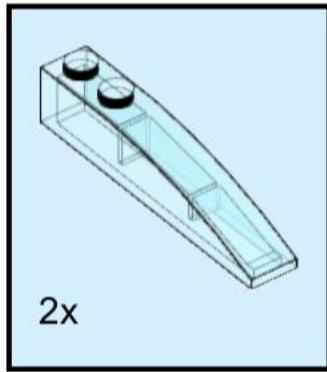

38

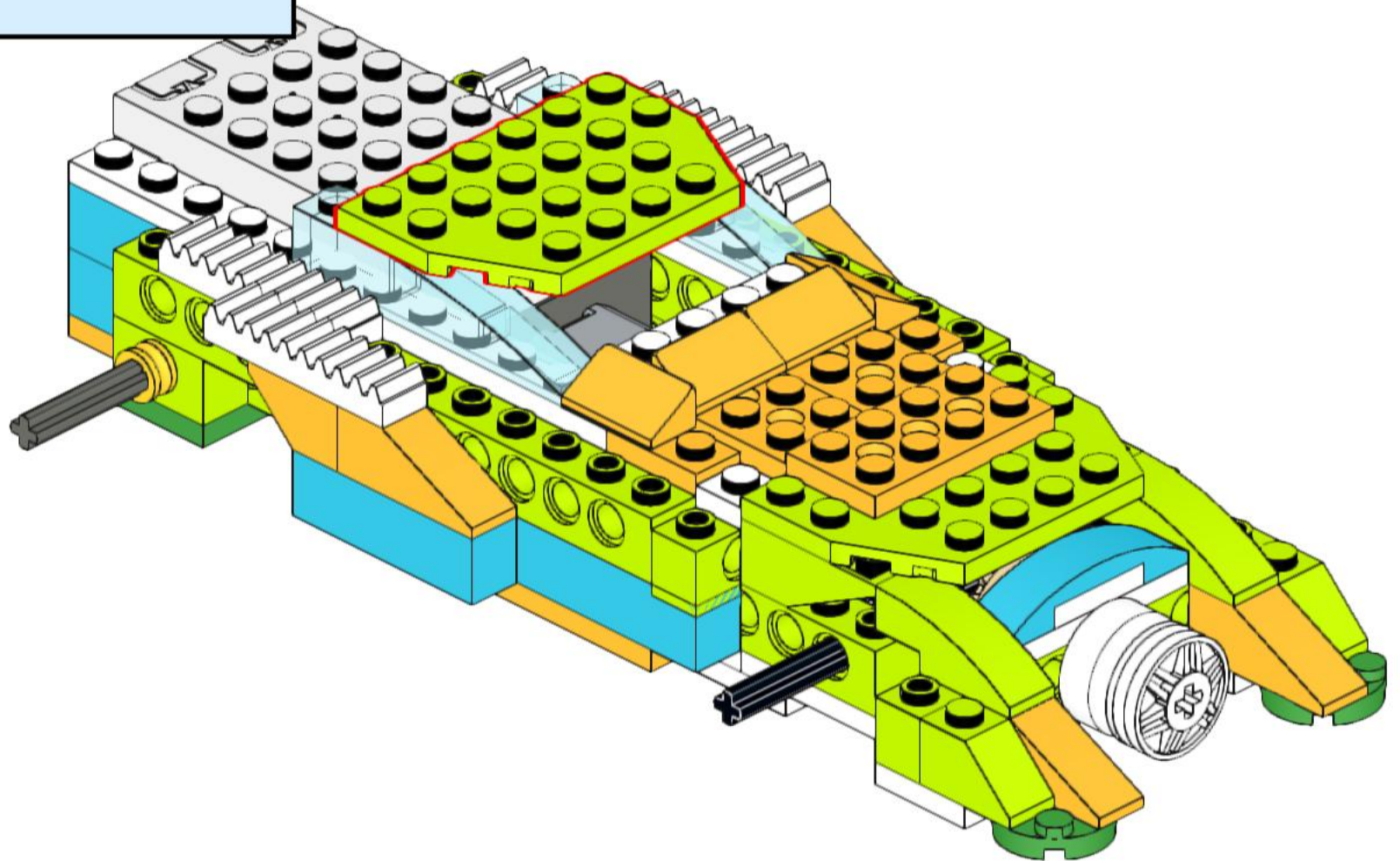
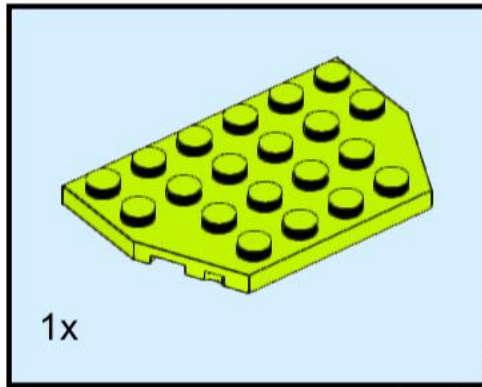

39

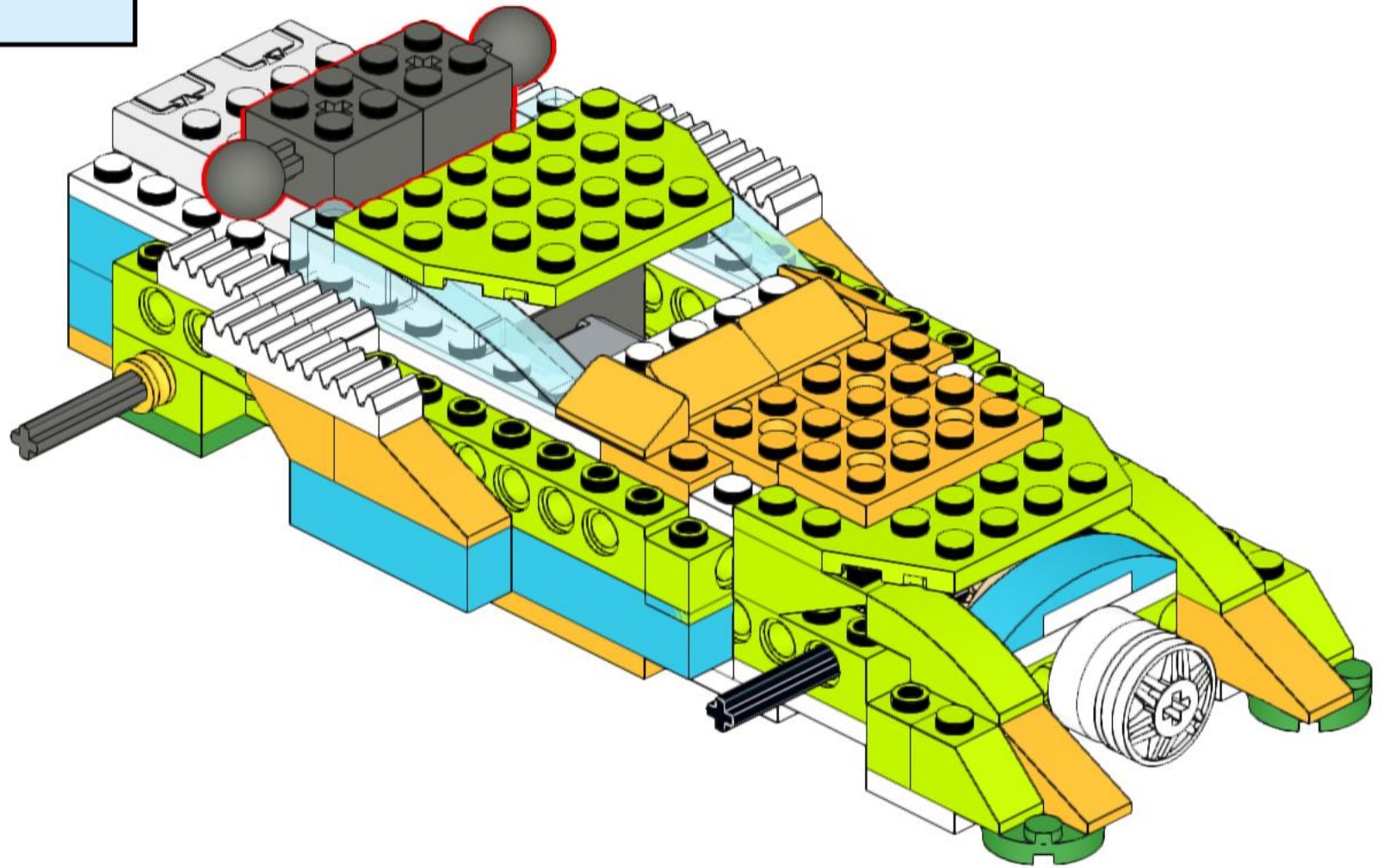
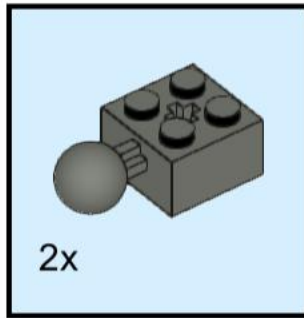

40

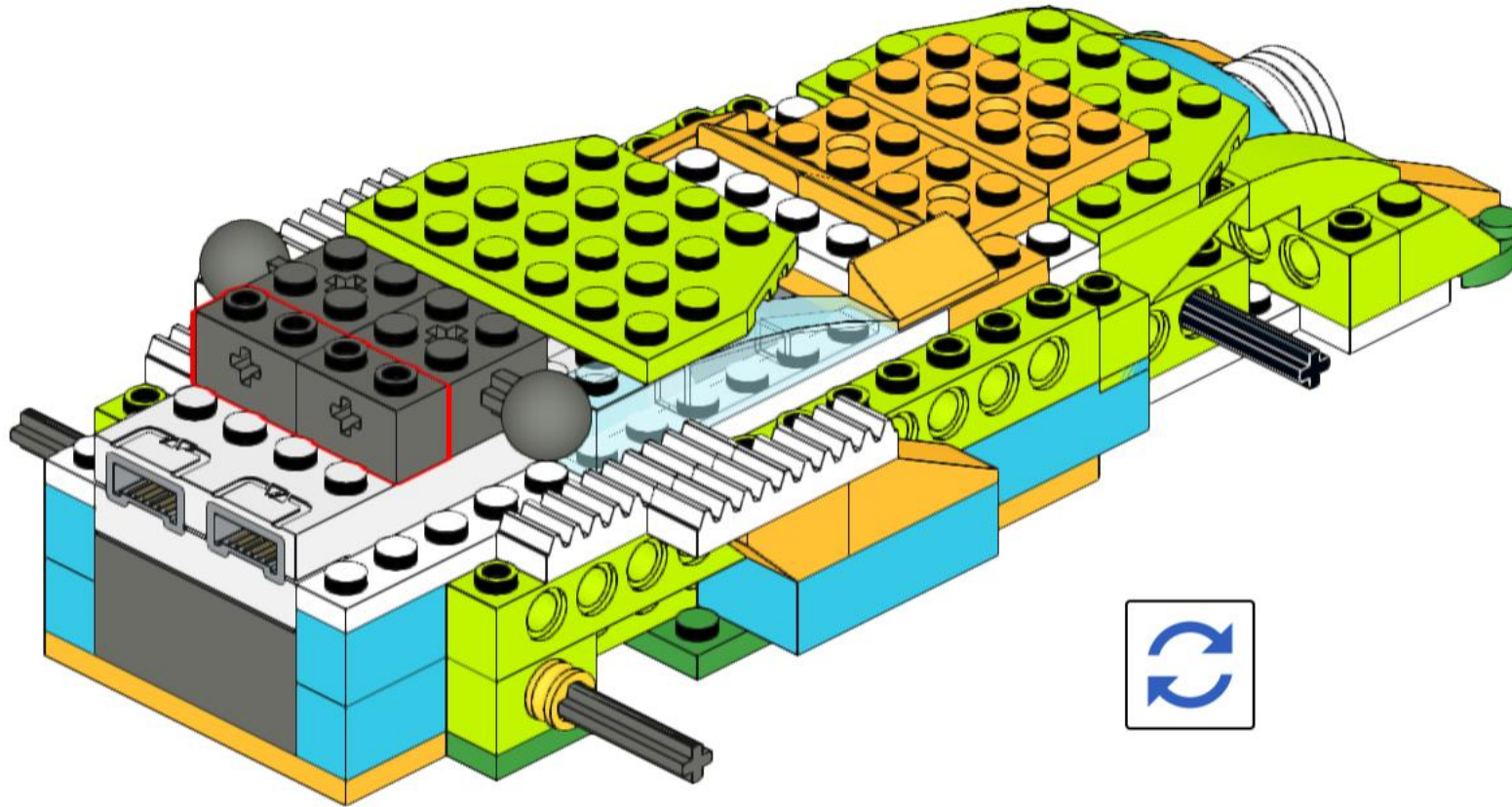
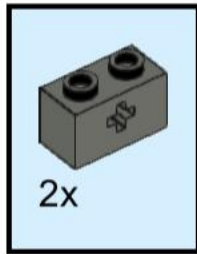

41

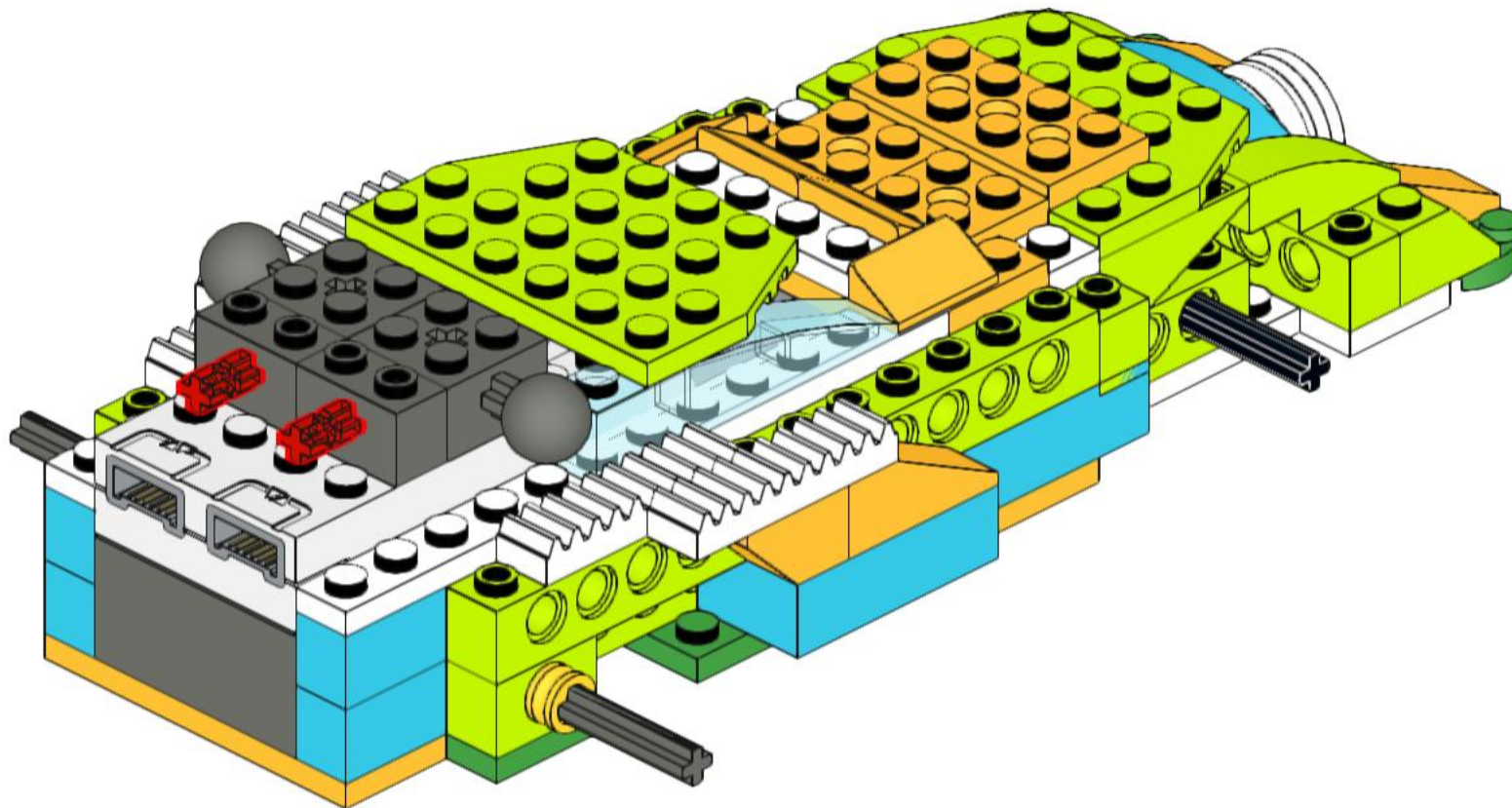
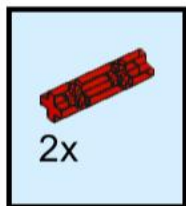

42

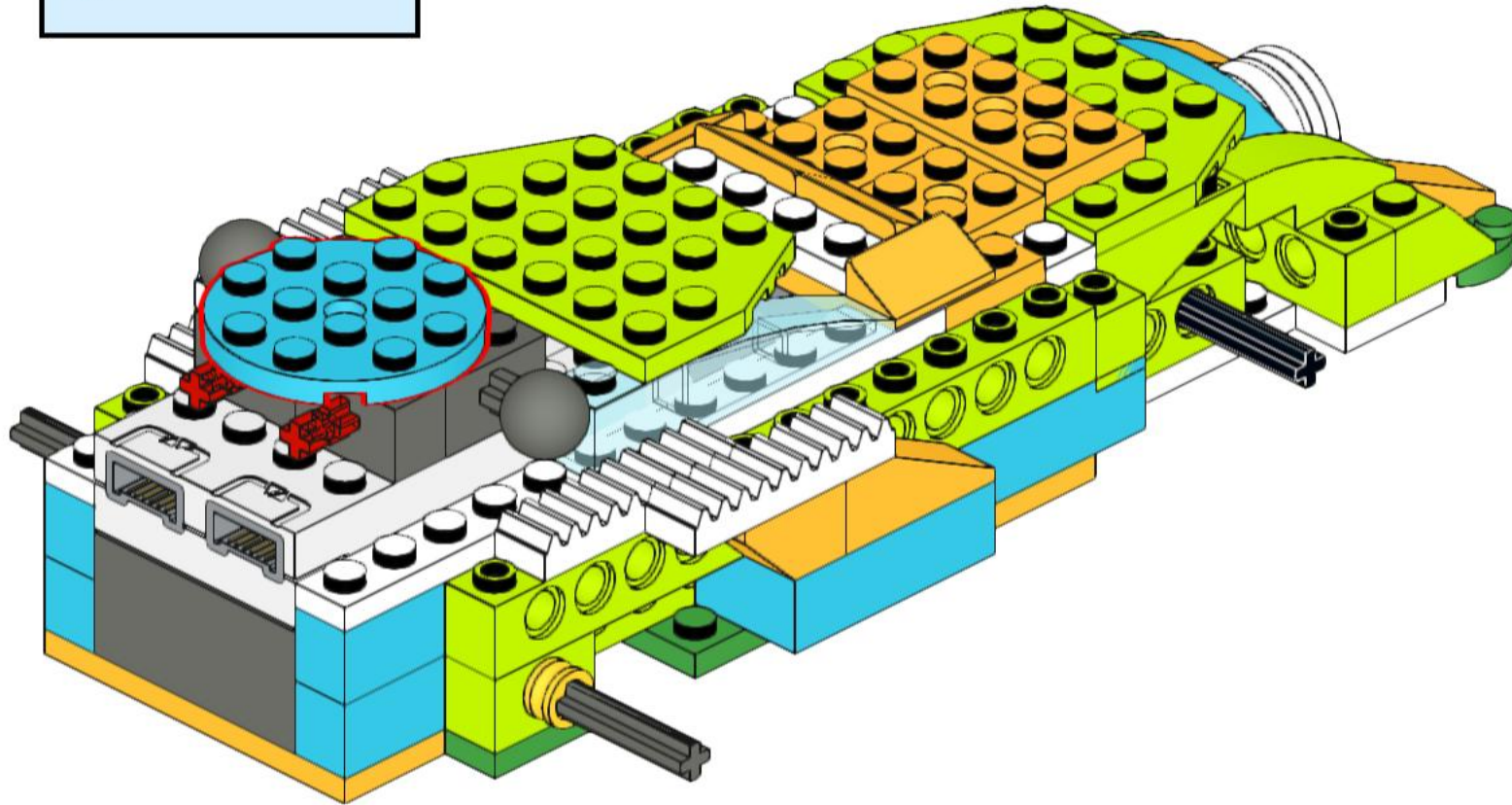
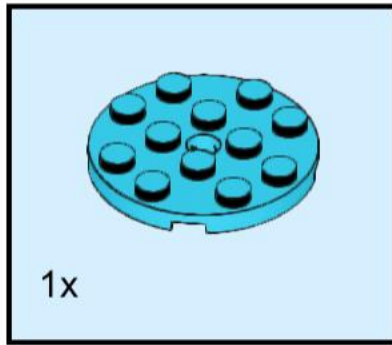

43

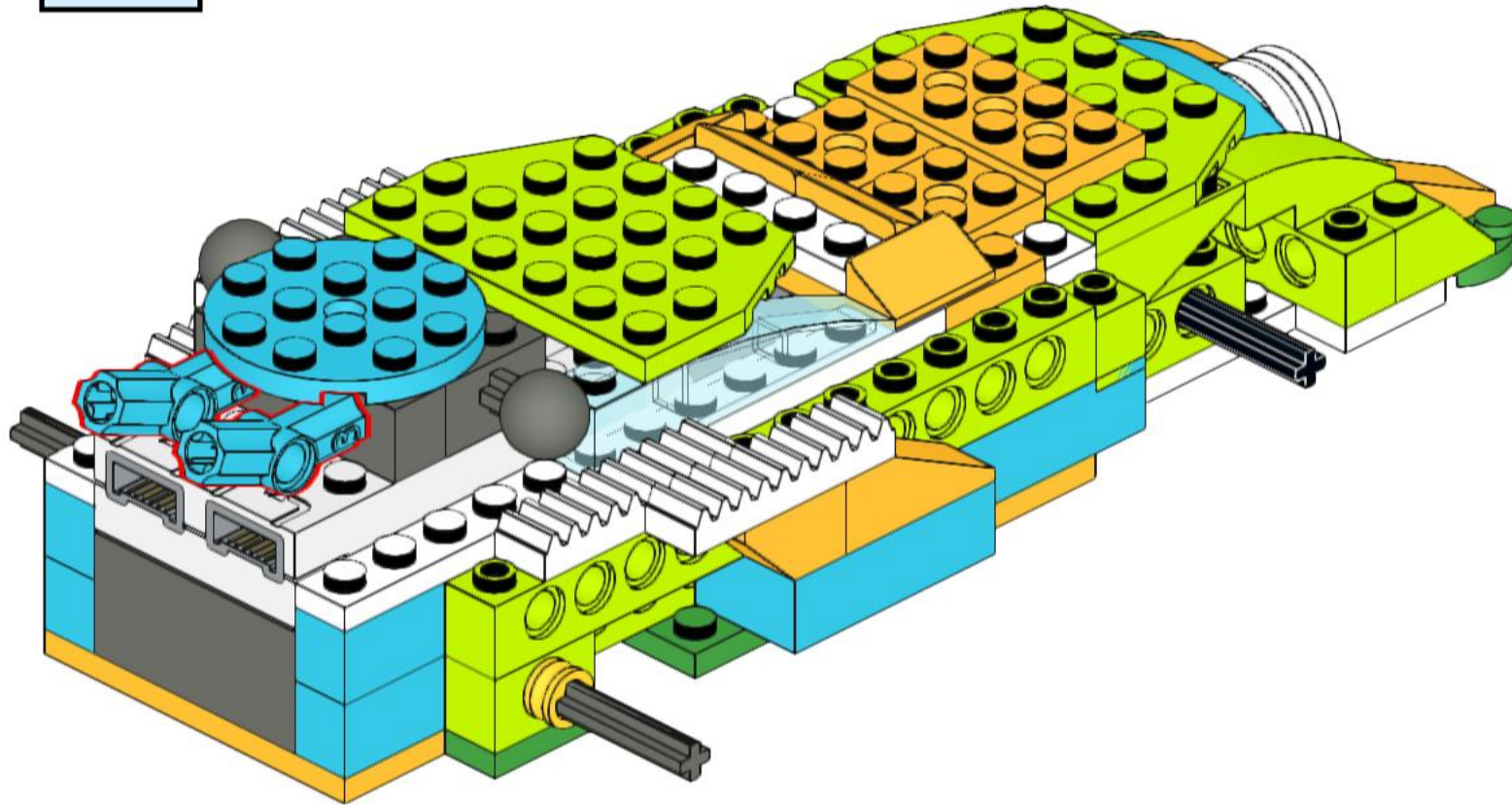
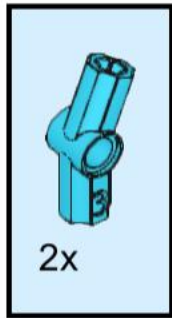

44

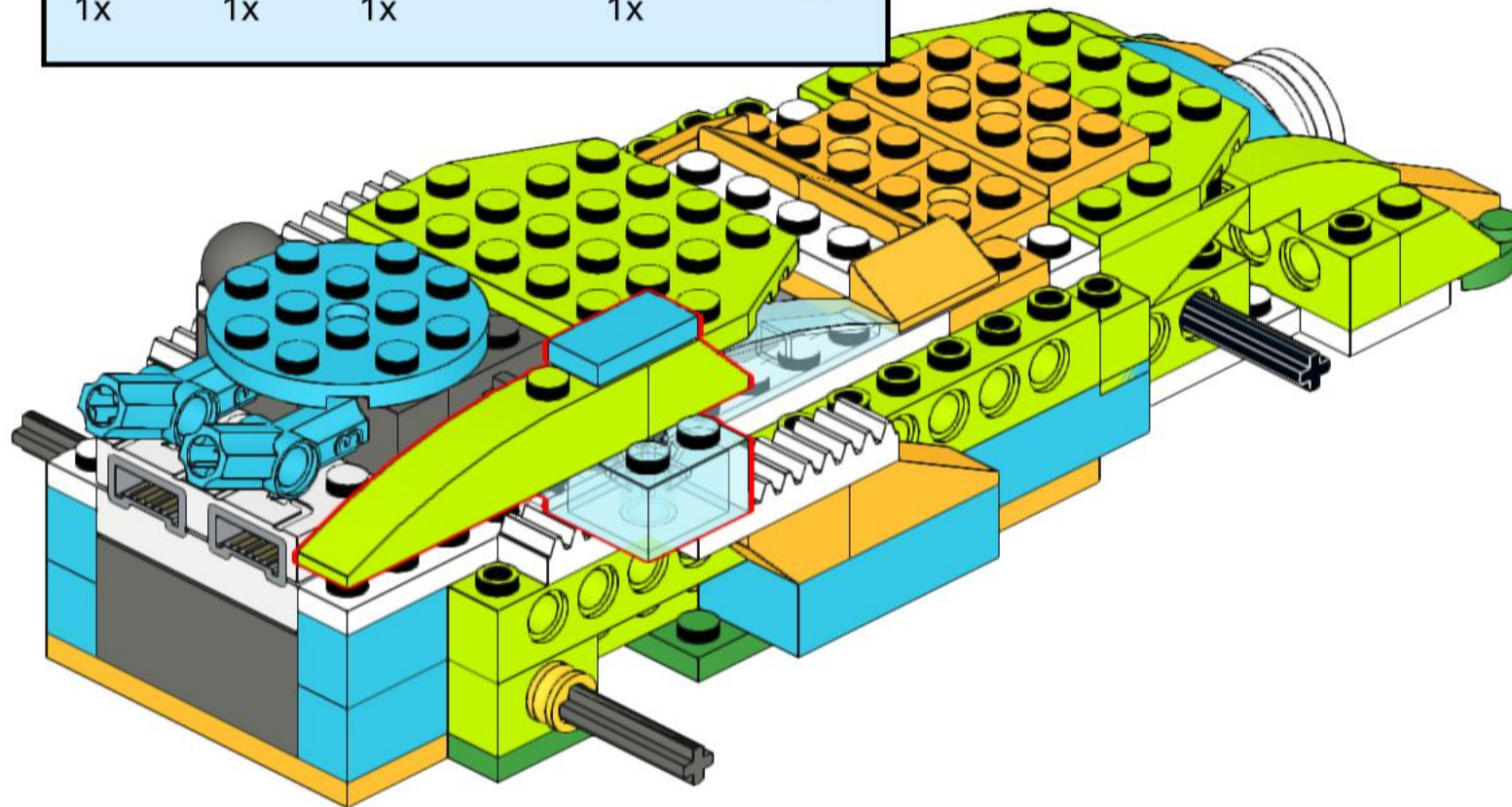
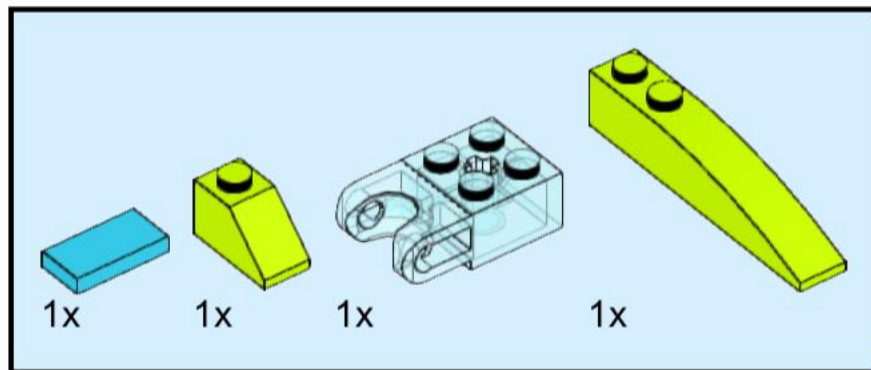

45

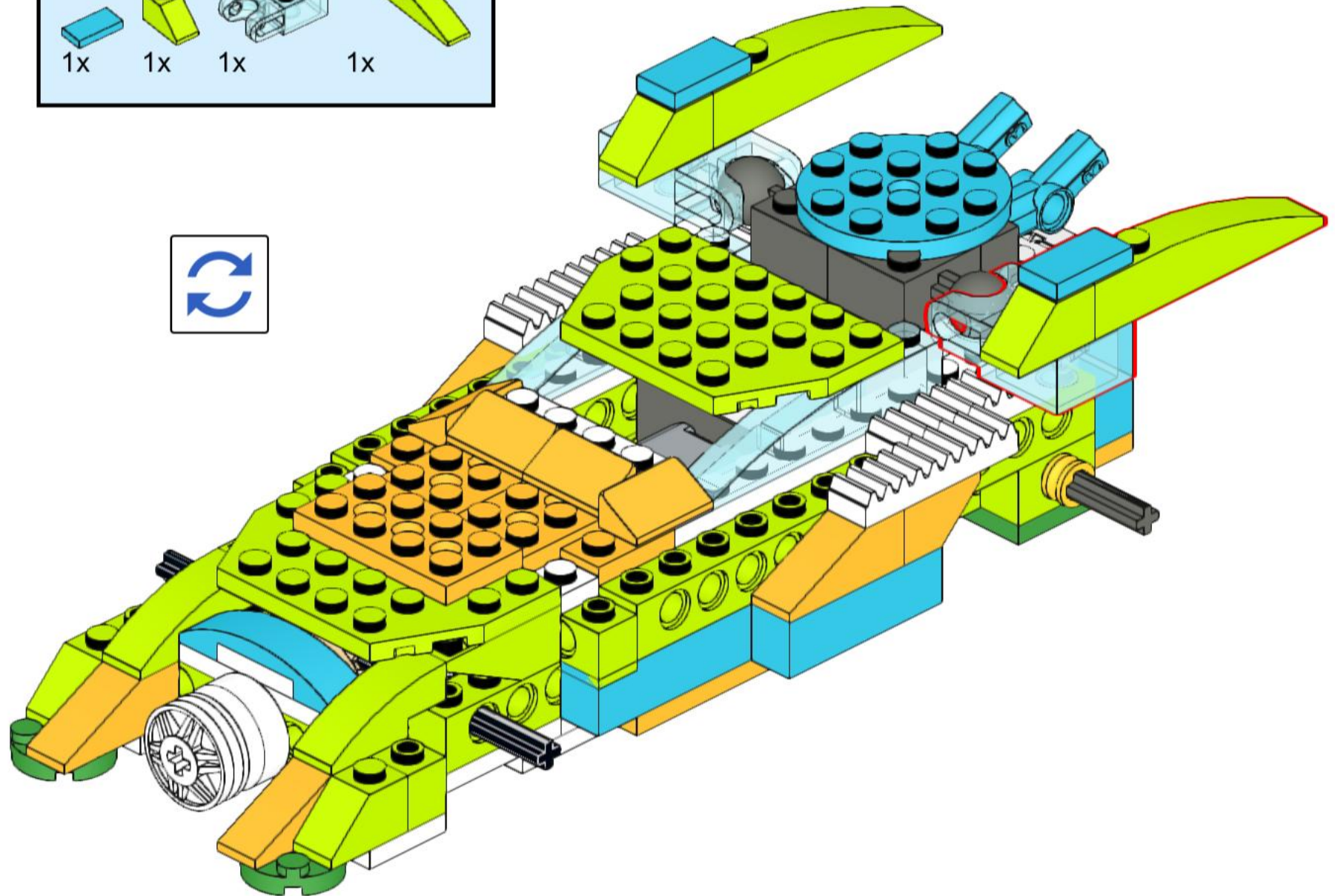
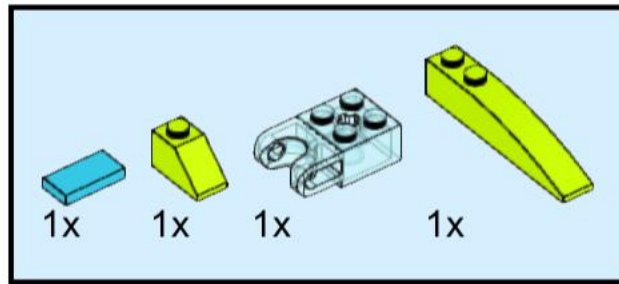

46

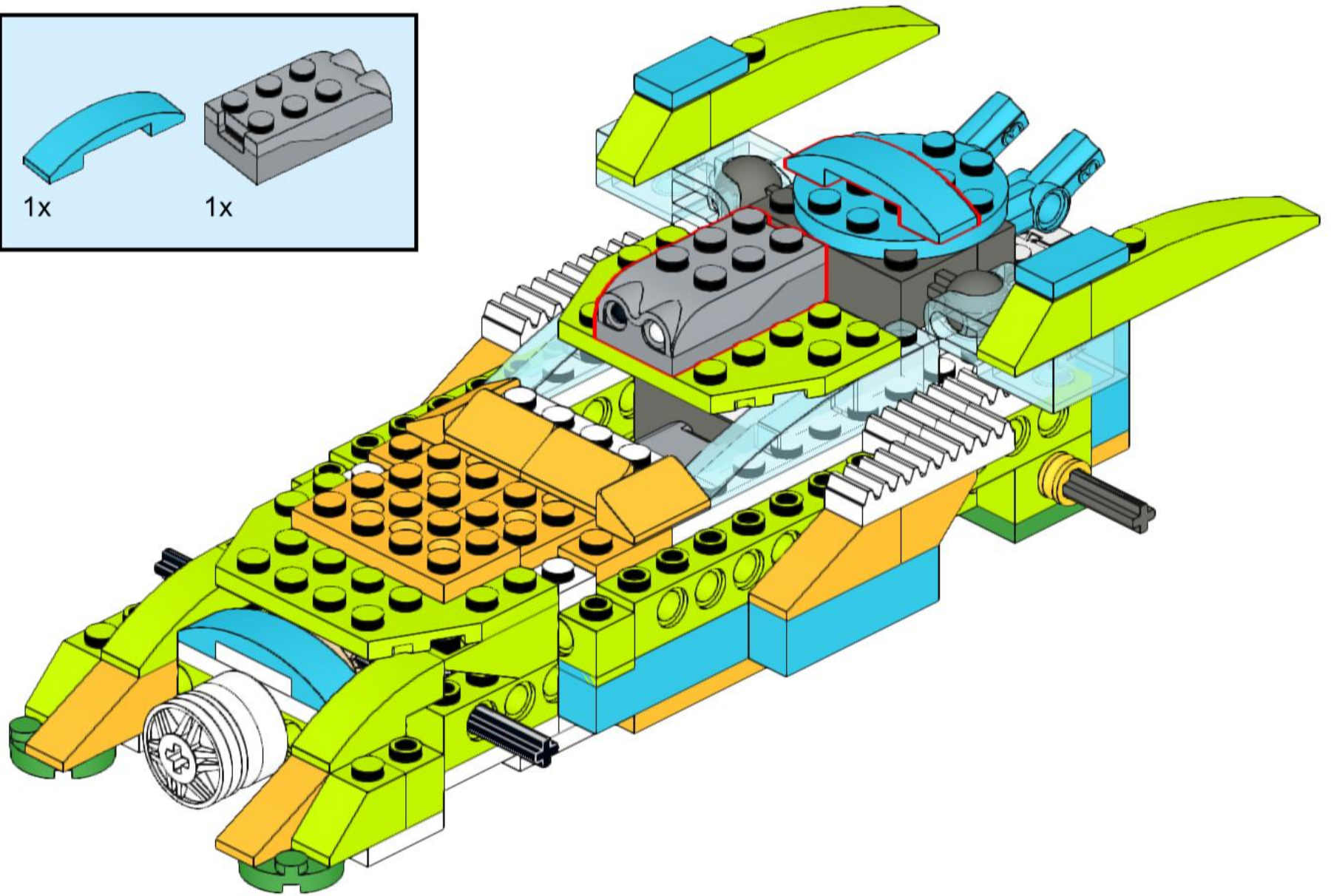
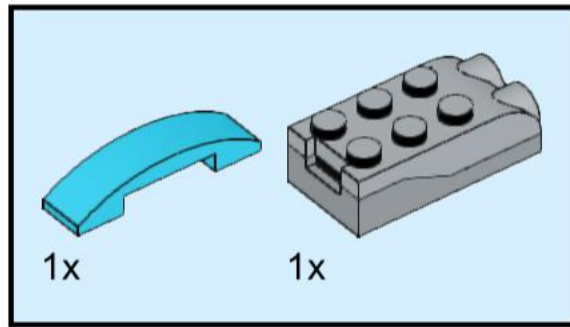

47

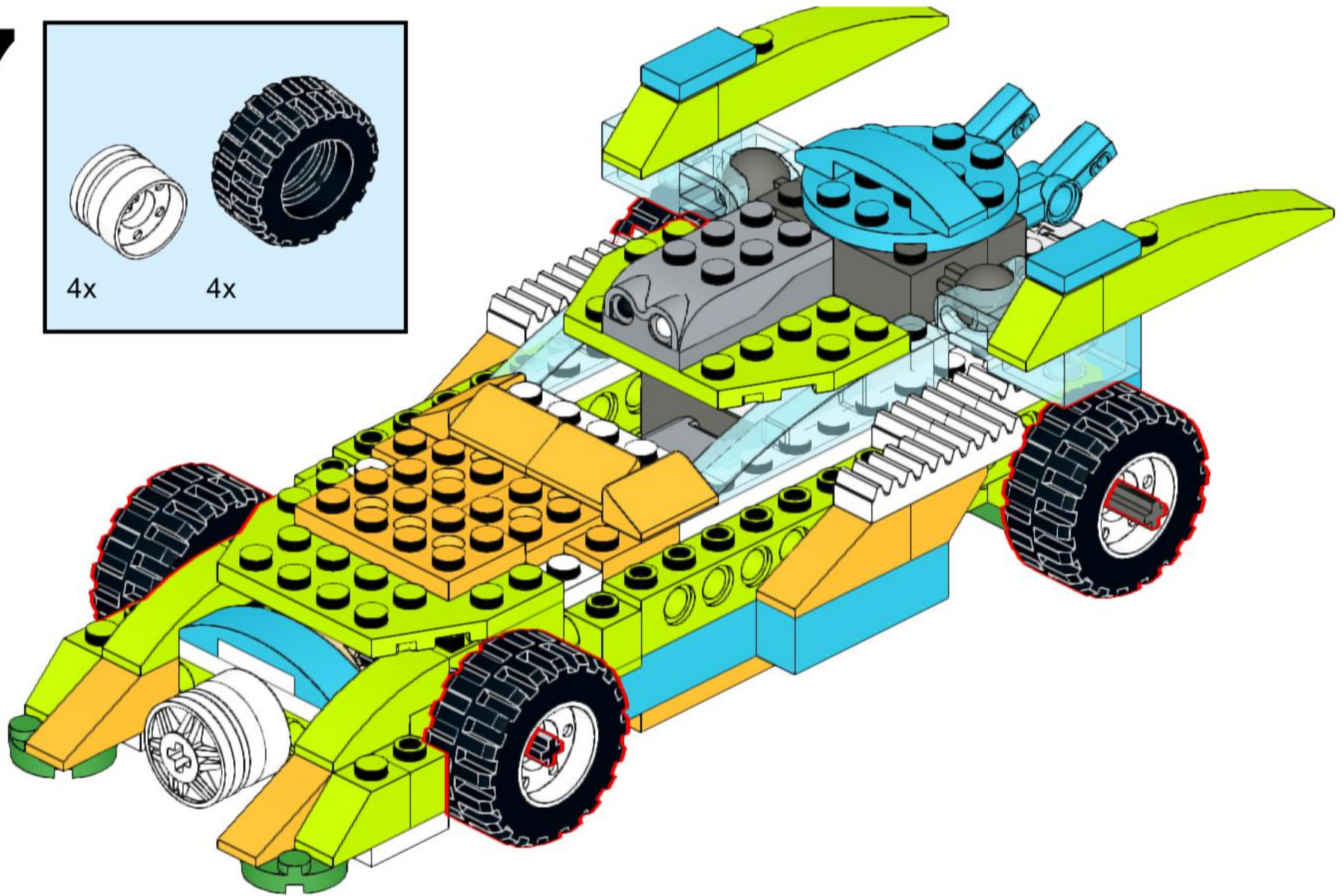
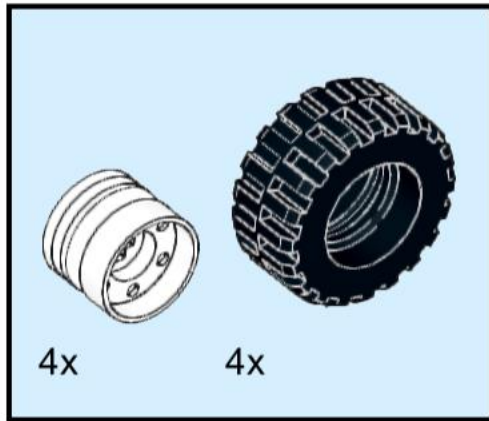

48

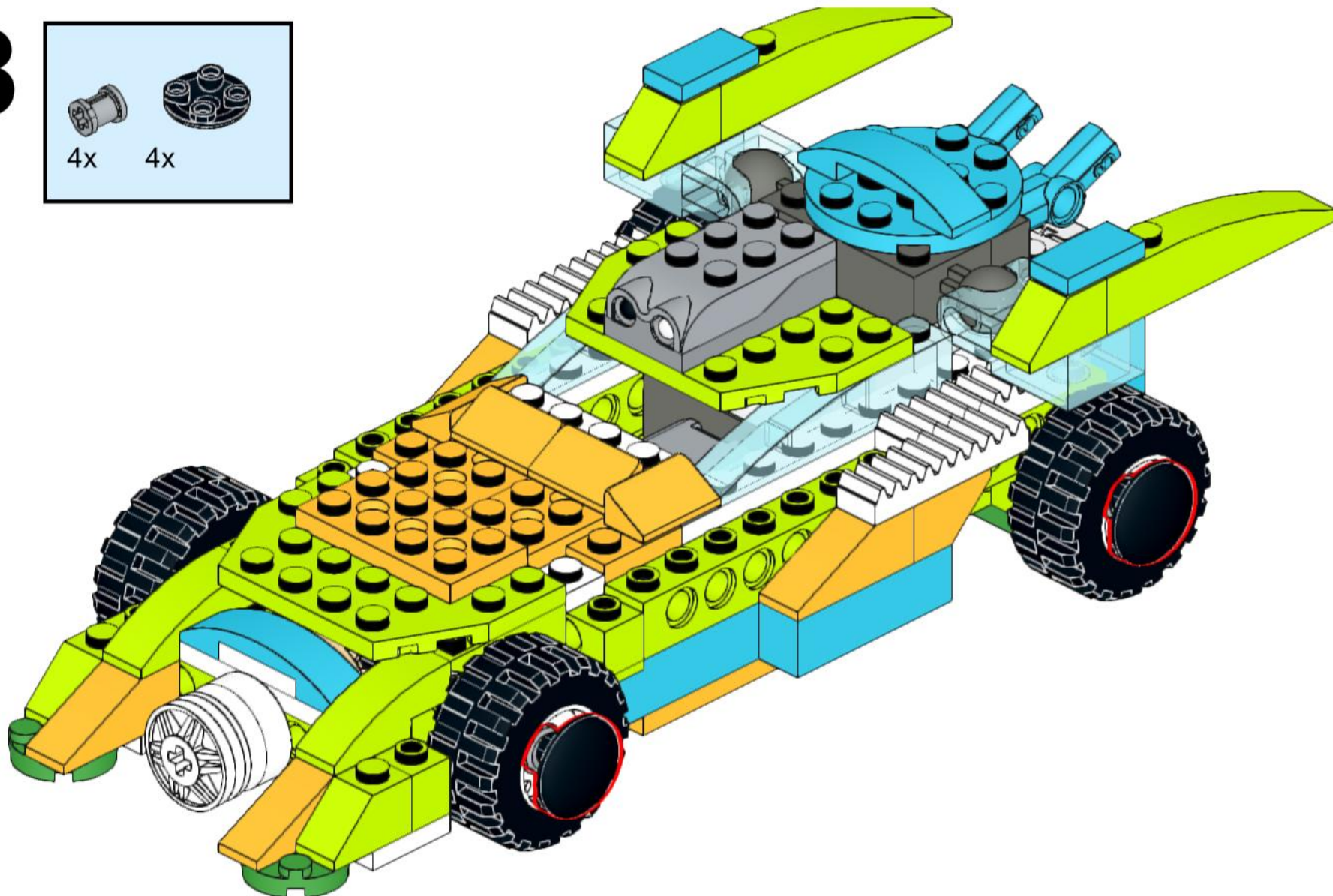
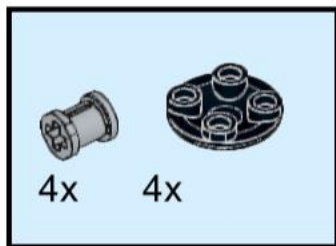

49

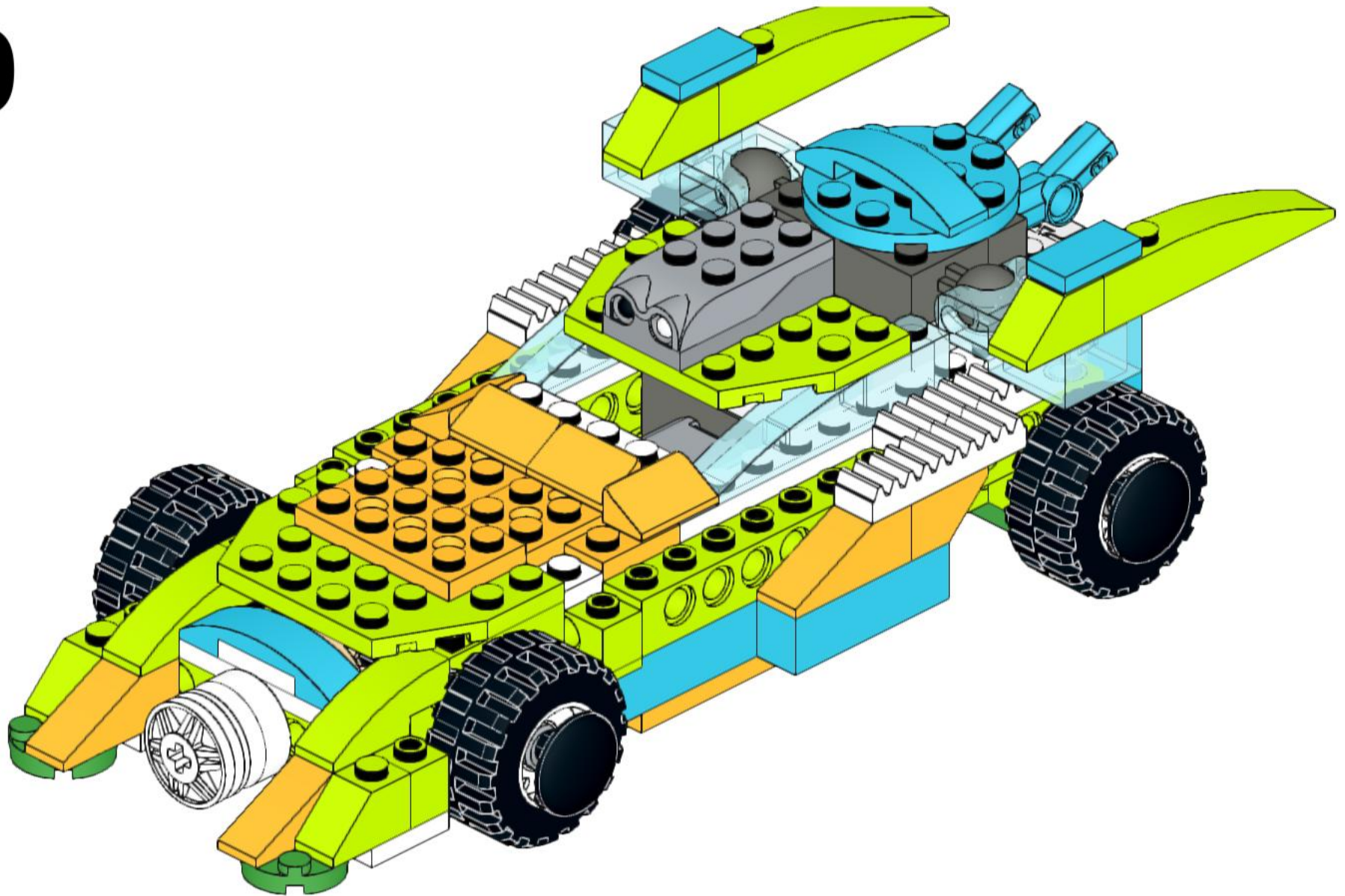



2x
2780, 11



2x
32064, 85



2x
4519, 86



4x
3710, 1



1x
32198, 2



4x
2654, 11



2x
87083, 85

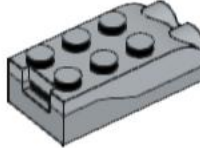

1x
20844, 86



4x
3743, 1



4x
85984, 110



2x
32269, 11

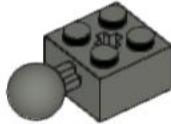

2x
57909b, 85

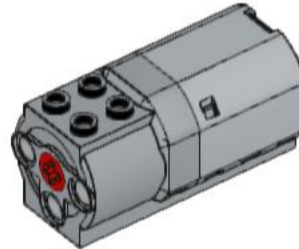

1x
21980, 86

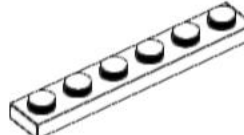

4x
3666, 1



2x
3665, 110



4x
92402, 11

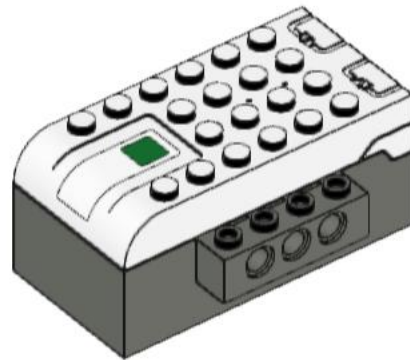

1x
21980, 86



3x
3023, 1

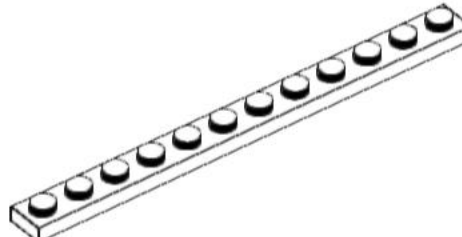

2x
60479, 1



4x
4286, 110



1x
3737, 11



1x
19071c01, 85



5x
55982, 1



2x
32062, 5

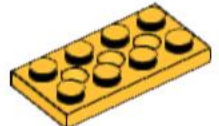

4x
3709b, 110



4x
3713, 86

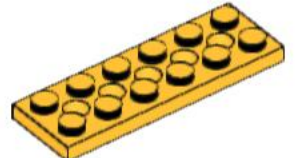

4x
32001, 110



3x
4265c, 3

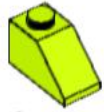

4x
3040, 34



4x
3700, 34



2x
50950, 34

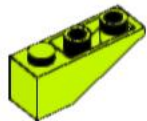

2x
4287, 34

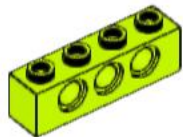

3x
3701, 34

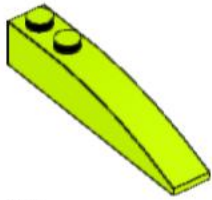

2x
42022, 34

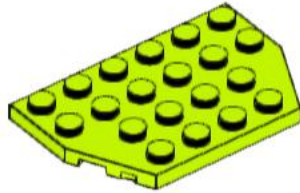

2x
32059, 34

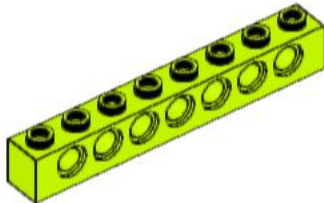

2x
3702, 34

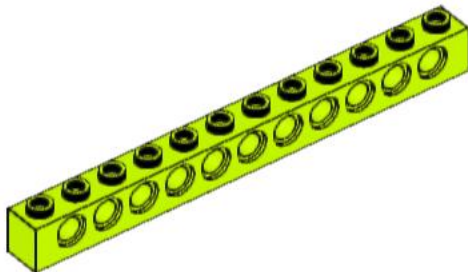

2x
3895, 34

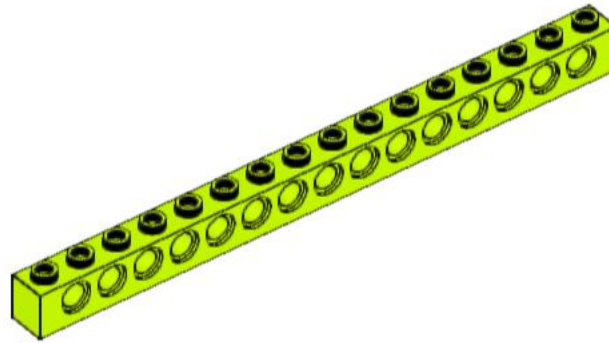

2x
3703, 34



2x
4032, 36

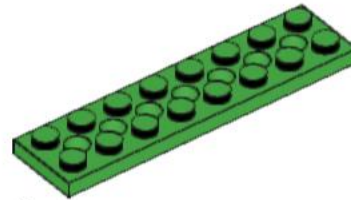

2x
3738, 36

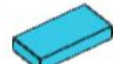

2x
3069b, 156

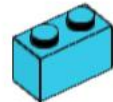

6x
3004, 156



2x
32016, 156

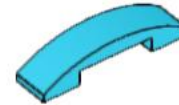

2x
93273, 156

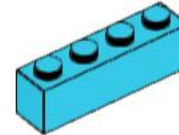

2x
3010, 156

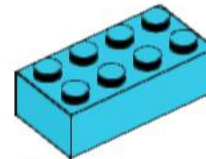

2x
3001, 156



1x
60474, 156

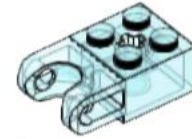

2x
92013, 15

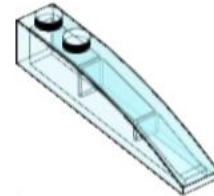

2x
42022, 15

